

SCORRITENDA E SISTEMI IN ALLUMINIO



ROBERTO PANZERI

ARTICOLI PER TAPPEZZIERI
SISTEMI PER TENDAGGI
PASSAMANERIA



ROBERTO PANZERI

ARTICOLI PER TAPPEZZIERI
SISTEMI PER TENDAGGI
PASSAMANERIA



SCORRITENDA E SISTEMI IN ALLUMINIO

ROBERTO PANZERI

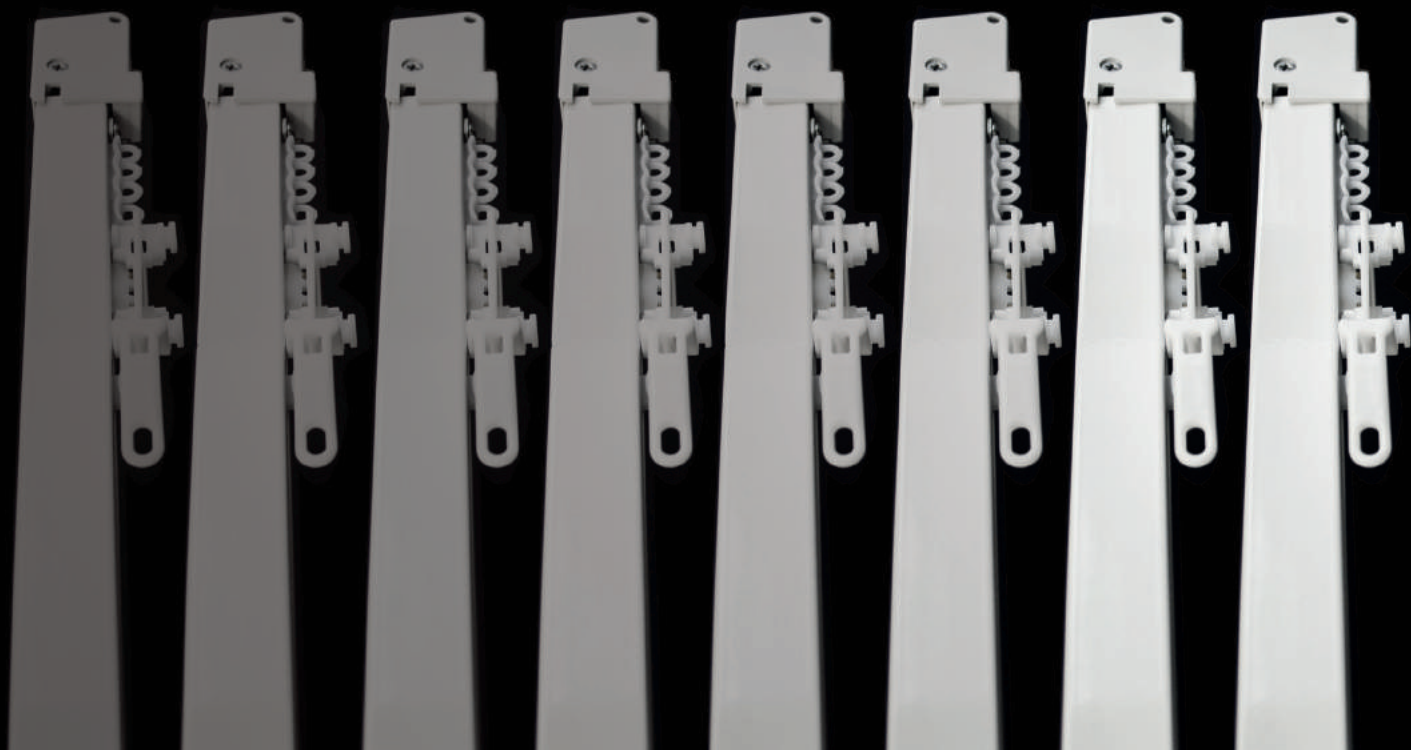

PRODOTTI

| | |
|--|-----|
| P430 - SISTEMA CURVABILE PER TENDE ARRICCIATE LEGGERE E MEDIE | _4 |
| P470 - SISTEMA CURVABILE PER TENDE ARRICCIATE LEGGERE - MEDIE - MEDIO PESANTI | _7 |
| P470/2 - SISTEMA PER TENDE ARRICCIATE A PACCHETTO | _10 |
| P490/2 - SISTEMA CURVABILE PER TENDE ARRICCIATE PESANTI | _12 |
| P421 - SISTEMA ULTRAPIATTO PER TENDE ARRICCIATE LEGGERE MEDIE - INSTALLAZIONE A SOFFITTO | _15 |
| P311 - SISTEMA ULTRAPIATTO MONOCANALE PER TENDE ARRICCIATE AD USO PRINCIPALMENTE DOMESTICO | _18 |
| P322 - SISTEMA ULTRAPIATTO A DOPPIO CANALE PER TENDE ARRICCIATE A GRANDE SORMONTO | _20 |
| P324 - SISTEMA A DOPPIO CANALE PER TENDE ARRICCIATE A GRANDE SORMONTO | _22 |
| P939 - SISTEMA DI TRASLAZIONE VERTICALE PER TENDE ARRICCIATE ED A PACCHETTO | _24 |
| P202 - SISTEMA PER TENDE ARRICCIATE PESANTI | _26 |
| P541 - SISTEMA CURVABILE A MOTORE PER TENDE ARRICCIATE MEDIO/LEGGERE | _28 |
| P477 - SISTEMA PER TENDE AD ARRICCIATURA CONTINUA AD ONDA CON AZIONAMENTO A STRAPPO E A CORDA | _31 |
| P205 - SISTEMA A DUE CANALI PER TENDE E SOPRATENDE USO DOMESTICO ED ALBERGHIERO | _34 |
| P441 - SISTEMA TENDE A PACCHETTO INSTALLAZIONE A SERRAMENTO | _37 |
| P419 - SISTEMA TENDE A PACCHETTO - INSTALLAZIONE A SERRAMENTO | _39 |
| P439 - SISTEMA PER TENDE A PACCHETTO ULTRAPIATTO AZIONAMENTO A CATENELLA INSTALLAZIONE A SERRAMENTO - LAVAGGIO RAPIDO | _41 |
| P414 - SISTEMA PER TENDE A PACCHETTO INSTALLAZIONE UNIVERSALE - AZIONAMENTO A CORDA | _44 |
| P427 - SISTEMA PER TENDE A PACCHETTO PESANTI, INCLINATE E/O STECCATE | _46 |
| P444 - SISTEMA CURVABILE PER TENDE A PACCHETTO CON AZIONAMENTO A CATENELLA | _48 |
| P445 - SISTEMA CURVABILE PER TENDE A PACCHETTO CON AZIONAMENTO A CATENELLA | _51 |
| P449 - SISTEMA PER TENDE A PACCHETTO CON AZIONAMENTO A MOTORE INSTALLAZIONE UNIVERSALE LAVAGGIO RAPIDO | _55 |
| P435/1 - SISTEMA COMPATTO PER TENDE A PACCHETTO CON AZIONAMENTO A CATENELLA | _58 |
| P440/1-2 - SISTEMA COMPATTO PER TENDE A PACCHETTO | _60 |
| P467/3 - SISTEMA COMPATTO PER TENDE A PACCHETTO | _62 |
| P542/3/4/5 - SISTEMA PER TENDE A PANNELLO | _64 |
| P1001 - SISTEMA CURVABILE PER TENDE ARRICCIATE LEGGERE E MEDIE | _68 |
| P1002 - SISTEMA CURVABILE PER TENDE ARRICCIATE LEGGERE E MEDIE | _70 |
| P1003 - SISTEMI A STRAPPO E A CORDE PER AMBIENTI DOMESTICI, NAUTICO E CARAVAN | _72 |
| P1004 - SISTEMA PER TENDE ARRICCIATE INDICATO PER PICCOLE FINESTRE | _73 |
| P1005 - SISTEMA PER TENDE A PACCHETTO CON AZIONAMENTO A CORDA | _75 |
| P1006 - SISTEMA PER TENDE A PACCHETTO CON AZIONAMENTO A CORDA | _77 |
| P1106 - SISTEMA VELCRATO PER TENDE TESE | _79 |
| P1126-36-46-56 - SISTEMA PER TENDE A PANNELLI A STRAPPO E CORDA | _80 |



P430

SISTEMA CURVABILE PER TENDE
ARRICCIATE LEGGERE E MEDIE



Dimensione profilo
L 16 mm
A 24 mm

Scala 1:1

Confezione standard con:

- art. P430 - Profilo alluminio bianco
- art. P4340 - Carrucole
- art. P4393 - Corda (caduta/225)
- art. P4348 - Fissacorda
- art. P4081 - Supporti a soffitto ogni 80 cm
- art. P4263 - Scivoli ogni 8-10 cm
- art. P4185 - Carrello di sormonto



Sistema ad uso principalmente domestico con azionamento a corda - corde guidate. Curvabile. Indicato per tende di peso medio. Installazione a: soffitto, a parete, libera sospensione.

FISSAGGIO

art. P4081 Supporto a soffitto

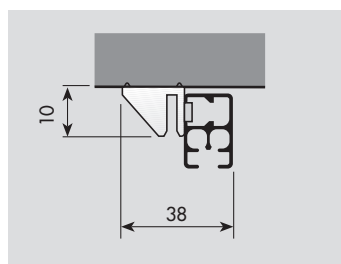

FISSAGGI OPZIONALI

art. P4083 Supporto a parete 3 cm

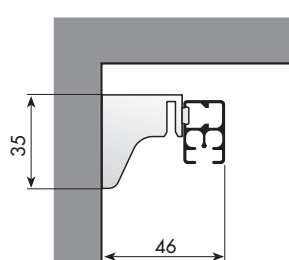

art. P4084 Supporto a parete 5.5 cm

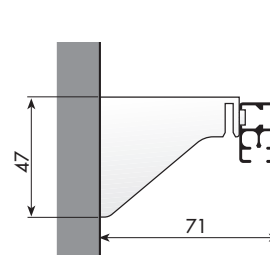

art. P4085 Supporto a parete 7.5 cm

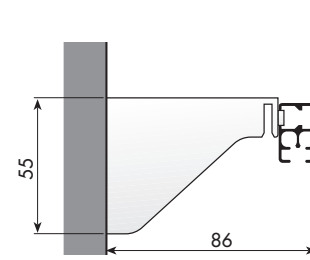

FISSAGGI OPZIONALI

art. P4142 Supporto a parete regolabile

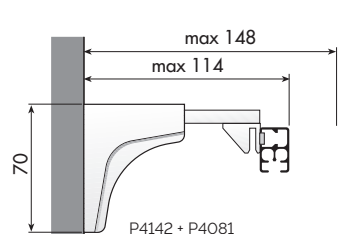

art. P4142 Supporto a parete regolabile

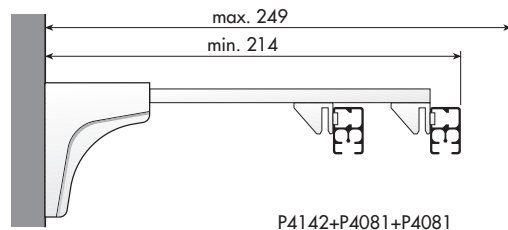

SCORREVOLI

art. P4263 Scivolo in materozza



art. P4550 Scivolo rotante



art. P4261 Scorrevole a rulli



PORTATA TENDA

Con Profilo a vista +30%

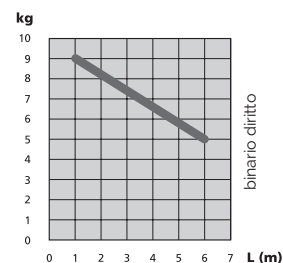

SISTEMAZIONI

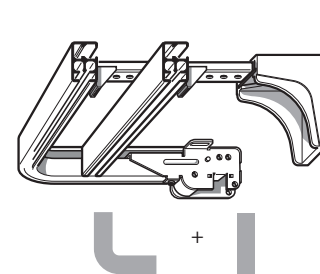
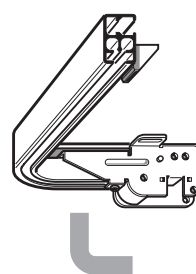
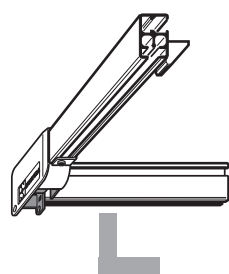
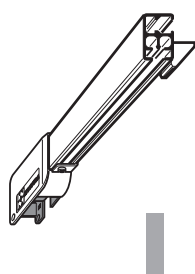

SUPPLEMENTI A RICHIESTA

| | art. | desc. | colore | euro |
|--|-------|--------------------|------------------|--------------|
| Supporti a parete 5,5 cm | P4084 | cad. | | 3,97 |
| Supporti a parete 7,0 cm | P4085 | cad. | | 4,22 |
| Binario portamantovana P520 B (con art. P4080) | P4080 | al m | | 26,06 |
| Curva 90° | | cad. min. 20/21 cm | | 7,73 |
| Angolo 90° | | cad. | | 3,81 |
| Scivolo a rullo | | al m | | 12,36 |
| Supplemento colore | | | bronzo - argento | +8 % |
| Supplemento colore | | | nero - oro | +20 % |
| Curva ampio raggio | | | | a preventivo |

P430

| LUNGHEZZA | 140 | 160 | 180 | 200 | 220 | 240 | 260 | 280 | 300 | 320 | 340 | 360 | 380 | 400 |
|------------------|-------|-------|-------|-------|-------|-------|-------|-------|-------|-------|-------|--------|--------|--------|
| PREZZO con CORDA | 60,97 | 63,96 | 65,61 | 67,57 | 71,07 | 73,54 | 79,36 | 84,00 | 91,41 | 95,28 | 99,14 | 104,34 | 109,13 | 116,65 |
| PREZZO a STRAPPO | 40,48 | 46,25 | 52,02 | 57,78 | 63,55 | 69,32 | 75,14 | 80,91 | 86,67 | 92,49 | 97,89 | 103,00 | 108,15 | 115,36 |

| LUNGHEZZA | 420 | 440 | 460 | 480 | 500 | 520 | 540 | 560 | 580 | 600 |
|------------------|--------|--------|--------|--------|--------|--------|--------|--------|--------|--------|
| PREZZO con CORDA | 124,27 | 130,76 | 138,23 | 145,75 | 153,32 | 158,36 | 163,36 | 170,93 | 178,45 | 184,89 |
| PREZZO a STRAPPO | 121,13 | 126,90 | 132,66 | 138,43 | 144,20 | 149,97 | 155,74 | 161,50 | 167,27 | 173,04 |

PROFILO ALLUMINIO 16X24 mm



| art. | imballo | colore | euro |
|------|---------|--------------------|-------|
| P430 | 60 m | argento/ grigio | 16,20 |
| P430 | 60 m | oro | 17,35 |
| P430 | 60 m | bronzo | 17,35 |
| P430 | 60 m | bianco | 17,35 |
| P430 | 60 m | nero | 17,35 |

*lunghezza aste 6 m

COPPIA CARRUCOLA

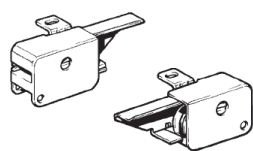

| art. | imballo | colore | euro |
|-------|---------|--------------------|-------|
| P4340 | 25 pz. | argento/ grigio | 14,73 |
| P4340 | 25 pz. | oro | 14,73 |
| P4340 | 25 pz. | bronzo | 14,73 |
| P4340 | 25 pz. | bianco | 14,73 |
| P4340 | 25 pz. | nero | 14,73 |

COPPIA GIROTENDA

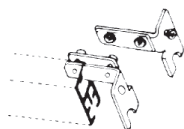

| art. | imballo | colore | euro |
|-------|---------|--------|------|
| P4345 | 20 cp. | bianco | 5,56 |

COPPIA STAFFE LATERALI A PARETE

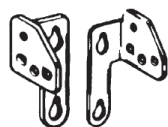

| art. | imballo | colore | euro |
|-------|---------|--------|------|
| P4346 | 15 pz. | bianco | 6,13 |

COPPIA FISSA CORDONI

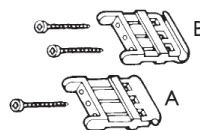

| art. | imballo | colore | euro |
|-------|---------|--------|------|
| P4348 | 15 pz. | bianco | 2,52 |

FISSA CORDONE SINGOLO



| art. | imballo | colore | euro |
|-------|---------|--------|------|
| P4349 | 50 pz. | bianco | 1,65 |

CORDA 100% NYLON Ø 3 mm



| art. | imballo | colore | euro |
|-------|---------|--------|--------|
| P4393 | 500 m | bianco | 106,81 |

SORMONTO IN PLASTICA

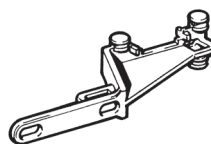

| art. | imballo | colore | euro |
|-------|---------|--------|------|
| P4185 | 100 pz. | | 2,94 |

SORMONTO IN PLASTICA 7 cm

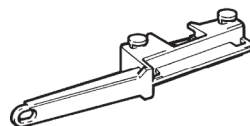

| art. | imballo | colore | euro |
|-------|---------|--------|------|
| P4585 | 50 pz. | | 3,35 |

CARRELLO GUIDATIRO

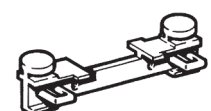

| art. | imballo | colore | euro |
|-------|---------|--------|------|
| P4182 | 50 pz. | | 1,91 |

ASTA DI SORMONTO

| art. | imballo | colore | euro |
|-------|---------|--------|------|
| P4184 | 50 pz. | | 2,78 |



SUPPORTO A SOFFITTO

| art. | imballo | colore | euro |
|-------|---------|--------|------|
| P4081 | 100 pz. | | 2,21 |

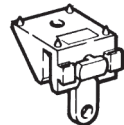

SUPPORTO A PARETE 3 cm

| art. | imballo | colore | euro |
|-------|---------|--------|------|
| P4083 | 100 pz. | | 2,78 |



SUPPORTO A PARETE 5,5 cm

| art. | imballo | colore | euro |
|-------|---------|--------|------|
| P4084 | 50 pz. | | 3,97 |

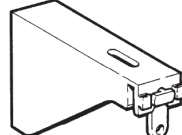

SUPPORTO A PARETE 7,0 cm

| art. | imballo | colore | euro |
|-------|---------|--------|------|
| P4085 | 50 pz. | | 4,22 |

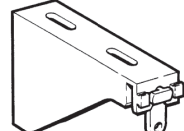

MENSOLA A PARETE REGOLABILE

| art. | sporgenza | imballo | euro |
|-------|-----------|---------|------|
| P4142 | 10-15 cm | 10 pz. | 5,10 |
| P4142 | 16-20 cm | 10 pz. | 5,67 |
| P4142 | 21-25 cm | 10 pz. | 6,03 |

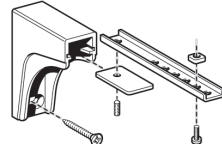

SCIVOLO IN MATEROZZA

| art. | imballo | colore | euro |
|-------|----------|--------|-------|
| P4263 | 1000 pz. | | 8,09* |



*prezzo per 100 pz.

SCIVOLO ROTANTE

| art. | imballo | colore | euro |
|-------|---------|--------|-------|
| P4550 | 500 pz. | | 16,12 |



*prezzo per 100 pz.

SCORREVOLE A RULLI

| art. | imballo | colore | euro |
|-------|---------|--------|------|
| P4261 | 500 pz. | | 1,30 |



ARRESTO GIREVOLE

| art. | imballo | colore | euro |
|-------|---------|--------|------|
| P4277 | 100 pz. | | 1,00 |



TENDICORDA DI SICUREZZA

| art. | imballo | colore | euro |
|-------|---------|--------|------|
| P3636 | 50 pz. | bianco | 3,15 |



FIOCCO UNIVERSALE 60g

| art. | imballo | colore | euro |
|-------|---------|--------|-----------|
| P1580 | 25 pz. | bianco | 2,38 cad. |



SUPPORTO PORTAMANTOVANA

| art. | imballo | mm | euro |
|-------|---------|-------|------|
| P4080 | 50 pz. | h. 10 | 3,35 |

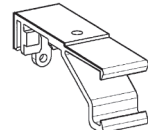

TAPPO TERMINALE

| art. | imballo | colore | euro |
|-------|---------|--------|------|
| P4338 | 50 pz. | bianco | 1,44 |

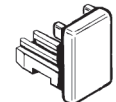

CONGIUNZIONE PER PROFILO

| art. | imballo | colore | euro |
|-------|---------|--------|------|
| P4113 | 10 pz. | | 8,03 |

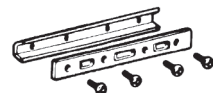

CARRUCOLA INTERMEDIA

| art. | imballo | colore | euro |
|-------|---------|--------------------|-------|
| P4336 | 4 cp. | argento/ grigio | 31,83 |
| P4336 | 4 cp. | oro | 31,83 |
| P4336 | 4 cp. | bronzo | 31,83 |
| P4336 | 4 cp. | bianco | 31,83 |

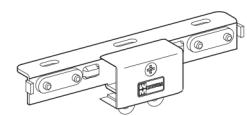

TIRANTE IN ALLUMINIO 120 cm

| art. | imballo | colore | euro |
|-------|---------|---------|-------|
| P4135 | 1 pz. | argento | 49,23 |



P470

SISTEMA CURVABILE PER TENDE ARRICCIATE
LEGGERE - MEDIE - MEDIO PESANTI



Dimensione profilo
L 18 mm
A 24,6 mm

Scala 1:1

Confezione standard con:

- art. P470 - Profilo alluminio bianco
- art. P4312 - Carrucole
- art. P4188 - Corda (Caduta/225 cm)
- art. P4195 - Fissacorda
- art. P4081 - Supporti a soffitto ogni 80 cm
- art. P4263 - Scivoli ogni 8-10 cm
- art. P4585 - Carrello di sormonto



Sistema ad uso domestico e professionale con azionamento a corda - corde guidate. Curvabile.
Indicato per tende semipesanti. Applicazione a: soffitto, a parete libera sospensione.

FISSAGGIO

art. P4081 Supporto a soffitto

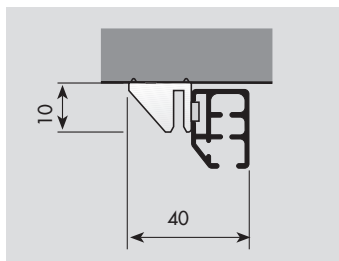

FISSAGGI OPZIONALI

art. P4083 Supporto a parete 3 cm

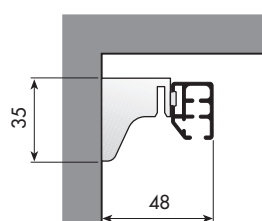

art. P4084 Supporto a parete 5 cm

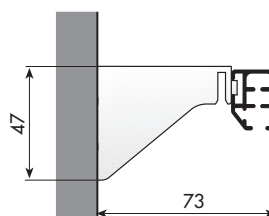

art. P4085 Supporto a parete 7 cm

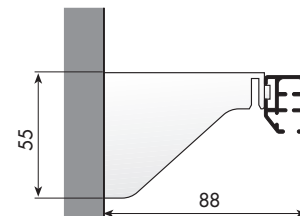

FISSAGGI OPZIONALI

art. P4142 Supporto a parete regolabile

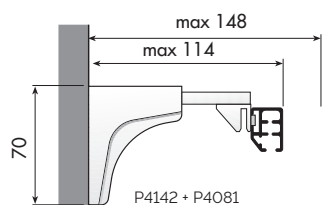

art. P4142 Supporto a parete regolabile

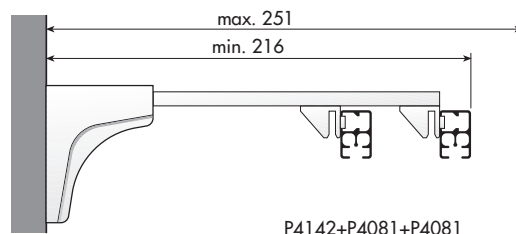

SCORREVOLI

art. P4263 Scivolo in materozza



art. P4144 Scorrevole a rulli



PORTATA TENDA

Con Profilo a vista +30%

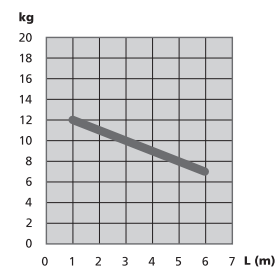

SISTEMAZIONI

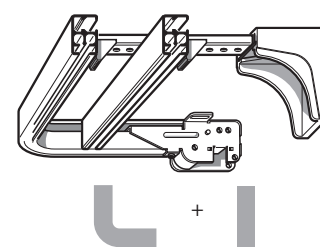
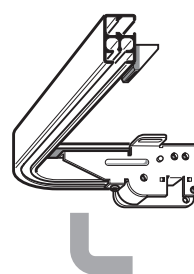
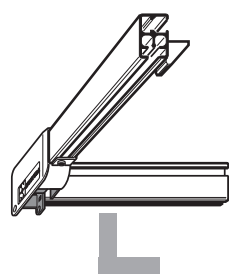
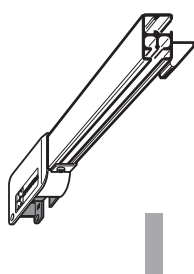

SUPPLEMENTI A RICHIESTA

| | art. | desc. | colore | euro |
|--------------------------|-------|--------------------|--------|------|
| Supporti a parete 5,5 cm | P4084 | cad. | | 3,97 |
| Supporti a parete 7,0 cm | P4085 | cad. | | 4,22 |
| Scorrevole a rulli | P4144 | al m | | 7,21 |
| Curva 90° | | cad. min. 20/21 cm | | 7,73 |
| Angolo 90° | | cad. | | 4,64 |

P470

| | | | | | | | | | | | | | | |
|------------------|--------|--------|--------|--------|--------|--------|--------|--------|--------|--------|--------|--------|--------|--------|
| LUNGHEZZA | 140 | 160 | 180 | 200 | 220 | 240 | 260 | 280 | 300 | 320 | 340 | 360 | 380 | 400 |
| PREZZO con CORDA | 71,48 | 75,60 | 76,89 | 79,16 | 82,92 | 87,96 | 93,01 | 98,06 | 101,82 | 106,81 | 110,57 | 113,09 | 116,91 | 120,66 |
| PREZZO a STRAPPO | 42,08 | 48,05 | 54,08 | 60,05 | 66,07 | 72,10 | 78,07 | 84,10 | 90,13 | 96,10 | 102,12 | 108,15 | 114,12 | 120,20 |
| LUNGHEZZA | 420 | 440 | 460 | 480 | 500 | 520 | 540 | 560 | 580 | 600 | | | | |
| PREZZO con CORDA | 124,42 | 126,95 | 131,94 | 138,02 | 141,63 | 148,32 | 153,32 | 158,36 | 163,36 | 170,93 | | | | |
| PREZZO a STRAPPO | 122,31 | 124,12 | 129,06 | 133,90 | 136,58 | 140,60 | 143,12 | 146,00 | 149,25 | 160,37 | | | | |

PROFILO ALLUMINIO 18X24,6 mm

| art. | imballo | colore | euro |
|------|---------|--------|-------|
| P470 | 72 m | bianco | 18,20 |



*lunghezza aste 6 m

COPIA CARRUCOLE

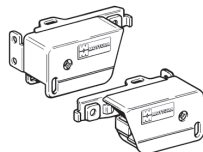

| art. | imballo | colore | euro |
|-------|---------|--------|-------|
| P4312 | 20 pz. | bianco | 15,45 |

COPIA FISSA CORDONI

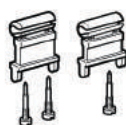

| art. | imballo | colore | euro |
|-------|---------|--------|------|
| P4195 | 50 pz. | | 2,64 |

FISSA CORDONE SINGOLO



| art. | imballo | colore | euro |
|-------|---------|--------|------|
| P4349 | 50 pz. | bianco | 1,65 |

FISSACORDA REGOLABILE

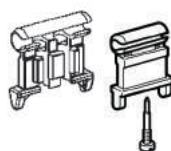

| art. | imballo | colore | euro |
|-------|---------|--------|------|
| P4197 | 50 pz. | | 3,87 |

COPIA GIROTENDA

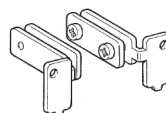

| art. | imballo | colore | euro |
|-------|---------|--------|------|
| P4314 | 20 pz. | | 7,16 |

SORMONTO IN PLASTICA

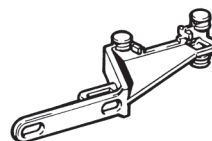

| art. | imballo | colore | euro |
|-------|---------|--------|------|
| P4185 | 100 pz. | | 2,94 |

SORMONTO IN PLASTICA 7 cm

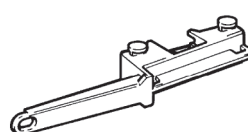

| art. | imballo | colore | euro |
|-------|---------|--------|------|
| P4585 | 50 pz. | | 3,35 |

CARRELLO GUIDATIRO

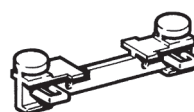

| art. | imballo | colore | euro |
|-------|---------|--------|------|
| P4182 | 50 pz. | | 1,91 |

CARRELLO GUIDA TIRO CON RUOTE

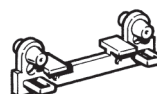

| art. | imballo | colore | euro |
|-------|---------|--------|-----------|
| P4181 | 50 pz. | | 3,62 cad. |

ASTA DI SORMONTO



| art. | imballo | colore | euro |
|-------|---------|--------|------|
| P4184 | 50 pz. | | 2,78 |

DISTANZIALE/SCIVOLO

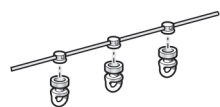

| art. | imballo | mm | euro |
|-------|---------|-------|-------|
| P4552 | 100 m. | 60 mm | 11,59 |
| P4552 | 100 m. | 80 mm | 10,86 |

SCIVOLO IN MATEROZZA



| art. | imballo | colore | euro |
|-------|----------|--------|-------|
| P4263 | 1000 pz. | | 8,09* |

*prezzo per 100 pz.

SCORREVOLE A RULLI



| art. | imballo | colore | euro |
|-------|---------|--------|--------|
| P4144 | 500 pz. | | 51,27* |

*prezzo per 100 pz.

SUPPORTO A SOFFITTO

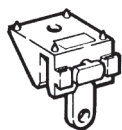

| art. | imballo | colore | euro |
|-------|---------|--------|------|
| P4081 | 100 pz. | | 2,21 |

SUPPORTO A PARETE 3 cm

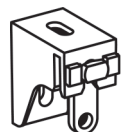

| art. | imballo | colore | euro |
|-------|---------|--------|------|
| P4083 | 100 pz. | | 2,78 |

SUPPORTO A PARETE 5,5 cm

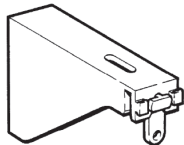

| art. | imballo | colore | euro |
|-------|---------|--------|------|
| P4084 | 50 pz. | | 3,97 |

SUPPORTO A PARETE 7,0 cm

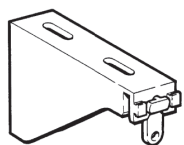

| art. | imballo | colore | euro |
|-------|---------|--------|------|
| P4085 | 50 pz. | | 4,22 |

MENSOLA A PARETE REGOLABILE

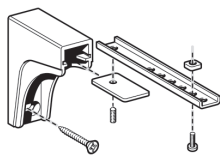

| art. | sporgenza | imballo | euro |
|-------|-----------|---------|------|
| P4142 | 10-15 cm | 10 pz. | 5,10 |
| P4142 | 16-20 cm | 10 pz. | 5,67 |
| P4142 | 21-25 cm | 10 pz. | 6,03 |

CORDA 100% NYLON Ø 3 mm



| art. | imballo | colore | euro |
|-------|---------|--------|--------|
| P4393 | 500 m | bianco | 106,81 |

TAPPO TERMINALE

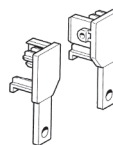

| art. | imballo | colore | euro |
|-------|---------|--------|------|
| P4316 | 50 pz. | bianco | 4,45 |

ARRESTO GIREVOLE



| art. | imballo | colore | euro |
|-------|---------|--------|------|
| P4277 | 100 pz. | | 1,00 |

CONGIUNZIONE PER PROFILO

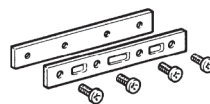

| art. | imballo | colore | euro |
|-------|---------|--------|------|
| P4589 | 10 pz. | | 7,71 |

CARRUCOLA INTERMEDIA



| art. | imballo | colore | euro |
|-------|---------|--------|-------|
| P4315 | 4 pz. | bianco | 31,82 |

TENDICORDA DI SICUREZZA



| art. | imballo | colore | euro |
|-------|---------|--------|------|
| P3636 | 50 pz. | bianco | 3,15 |

FIOTTO UNIVERSALE 60g



| art. | imballo | colore | euro |
|-------|---------|--------|-----------|
| P1580 | 25 pz. | bianco | 2,38 cad. |

P470/2

SISTEMA PER TENDE ARRICCIATE A PACCHETTO



Dimensione profilo
L 18 mm
A 24,6 mm

Scala 1:1

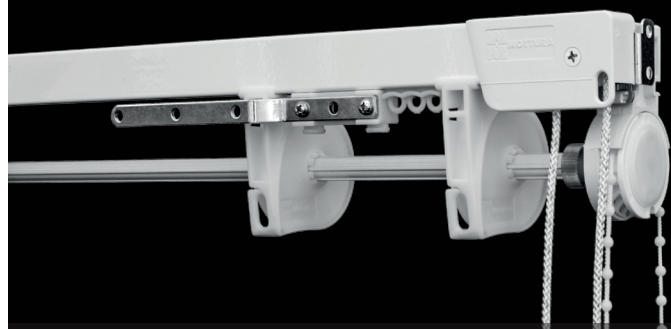

Confezione standard con:

- art. P470/2 - Profilo alluminio bianco
- art. P4312 - Carrucole
- art. P4188 - Corda (Caduta 225 cm)
- art. P4195 - Fissacorda
- art. P4081 - Supporti a soffitto ogni 80 cm
- art. P4263 - Scivoli ogni 8-10 cm
- art. P4596 - Carrello di sormonto
- art. P4598 - Frizione diretta
- art. P4594 - Rocchetti avvolginastro
- art. P4593 - Alberino
- art. P1931 - Nastro (320 cm)

Corde guidate. Solo binari dritti. Applicazione a soffitto e a parete.

FISSAGGIO

art. P4081 Supporto a soffitto

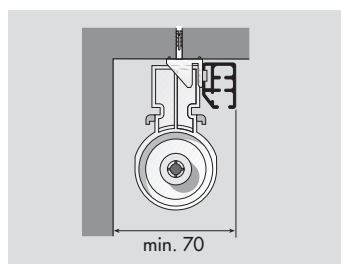

FISSAGGI OPZIONALI

art. P4084 Supporto a parete 5 cm

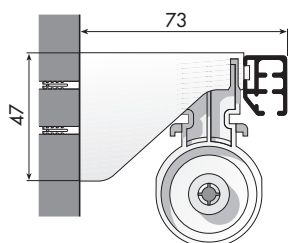

art. P4085 Supporto a parete 7 cm

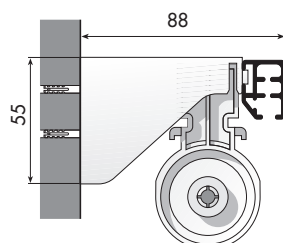

art. P4142 Supporto a parete regolabile

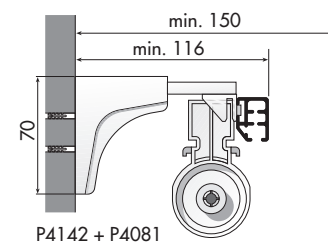

SISTEMAZIONE

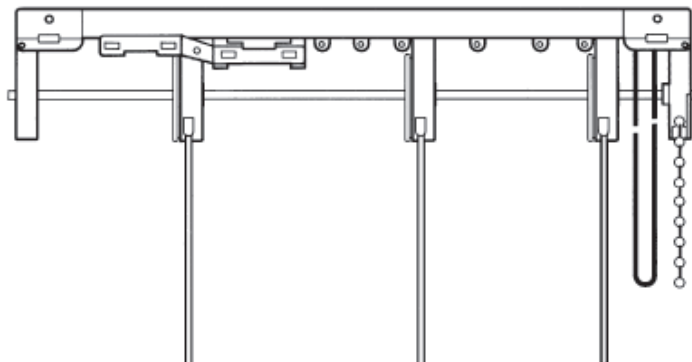

PORTATA TENDA

Portata max ogni
singolo rocchetto: 0,5 kg

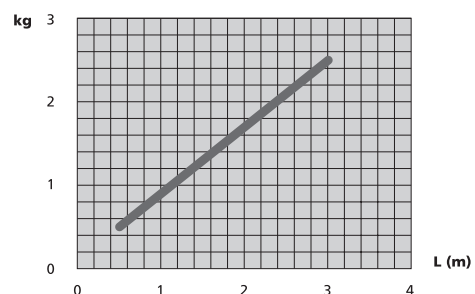

SUPPLEMENTI A RICHIESTA

| | art. | desc. | colore | euro |
|--------------------------|-------|-------|--------|------|
| Supporti a parete 5,5 cm | P4084 | cad. | | 3,97 |
| Supporti a parete 7,0 cm | P4085 | cad. | | 4,22 |
| Scorrevole a rulli | P4144 | cad. | | 7,21 |

P470/2

| LUNGHEZZA | 140 | 160 | 180 | 200 | 220 | 240 | 260 | 280 | 300 |
|----------------|--------|--------|--------|--------|--------|--------|--------|--------|--------|
| NUMERO CADUTE | 5 | 5 | 6 | 6 | 7 | 7 | 8 | 8 | 9 |
| PREZZO a CORDA | 138,58 | 149,30 | 159,86 | 173,19 | 186,48 | 199,82 | 213,11 | 226,45 | 239,78 |

PROFILO ALLUMINIO 18X24,6 mm

| art. | imballo | colore | euro |
|------|---------|--------|-------|
| P470 | 72 m | bianco | 18,20 |



*lunghezza aste 6 m

COPPIA CARRUCOLE

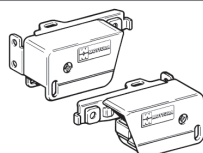

| art. | imballo | colore | euro |
|-------|---------|--------|-------|
| P4312 | 20 pz. | bianco | 15,45 |

COPPIA FISSA CORDONI

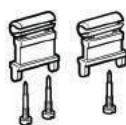

| art. | imballo | colore | euro |
|-------|---------|--------|------|
| P4195 | 50 pz. | | 2,64 |

SCIVOLO IN MATEROZZA



| art. | imballo | colore | euro |
|-------|----------|--------|-------|
| P4263 | 1000 pz. | | 8,09* |

*prezzo per 100 pz.

SUPPORTO A PARETE 5,5 cm

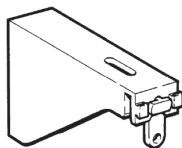

| art. | imballo | colore | euro |
|-------|---------|--------|------|
| P4084 | 50 pz. | | 3,97 |

SUPPORTO A PARETE 7,0 cm

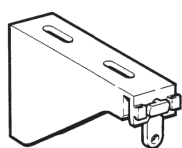

| art. | imballo | colore | euro |
|-------|---------|--------|------|
| P4085 | 50 pz. | | 4,22 |

MENSOLA A PARETE REGOLABILE

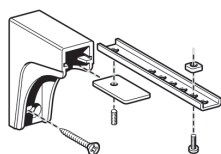

| art. | sporgenza | imballo | euro |
|-------|-----------|---------|------|
| P4142 | 10-15 cm | 10 pz. | 5,10 |
| P4142 | 16-20 cm | 10 pz. | 5,67 |
| P4142 | 21-25 cm | 10 pz. | 6,03 |

CORDA 100% NYLON Ø 3,5 mm



| art. | imballo | colore | euro |
|-------|---------|--------|--------|
| P4188 | 400 m | bianco | 103,70 |

ANELLO CATENA PASSO 6mm



| art. | imballo | colore | euro |
|-------|---------|--------|------|
| P3624 | 15 pz. | bianco | |

FRIZIONE DIRETTA

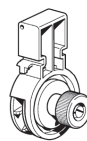

| art. | imballo | colore | euro |
|-------|---------|--------|-------|
| P4598 | 15 pz. | | 14,63 |

ROCCHETTO AVVOLGITORE



| art. | imballo | colore | euro |
|-------|---------|--------|------|
| P4594 | 40 pz. | | 5,10 |

NASTRO 5 mm



| art. | imballo | colore | euro |
|-------|---------|--------|------|
| P1931 | 150 m | bianco | 0,50 |
| P1931 | 150 m | trasp. | 0,63 |

*prezzo al m

SUPPORTO ALBERINO



| art. | imballo | colore | euro |
|-------|---------|--------|------|
| P4597 | 30 pz. | | 1,78 |

ALBERINO SCANALATO

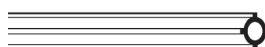

| art. | imballo | colore | euro |
|-------|---------|--------|------|
| P4593 | 60 m | bianco | 6,84 |

*lunghezza aste 6 m

SORMONTO

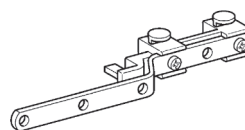

| art. | imballo | colore | euro |
|-------|---------|--------|------|
| P4596 | 50 pz. | | 3,98 |

TENDICORDA DI SICUREZZA



| art. | imballo | colore | euro |
|-------|---------|--------|------|
| P3636 | 50 pz. | bianco | 3,15 |

FIOCCO UNIVERSALE 60g



| art. | imballo | colore | euro |
|-------|---------|--------|-----------|
| P1580 | 25 pz. | bianco | 2,38 cad. |

P490/2

SISTEMA CURVABILE PER TENDE ARRICCIATE PESANTI



Dimensione profilo
L 22 mm
A 24 mm

Scala 1:1



Confezione standard con:

- art. P490/... - Profilo alluminio bianco
- art. P4580 - Carrucole
- art. P4188 - Corda (Caduta 225 cm)
- art. P4586 - Fissacorda
- art. P4081 - Supporti a soffitto ogni 80 cm
- art. P5018 - Scivoli
- art. P5327 - Asta di sormonto

Sistema ad uso domestico e professionale con azionamento a corde - corde guidate. Curvabile. Scorrevoli a rullo. Indicato per tende pesanti. Applicazione a: soffitto, a parete, libera sospensione (vedere accessori).

FISSAGGIO

art. P4081 Supporto a soffitto

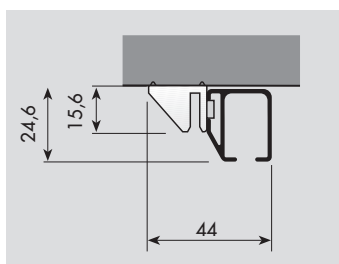

FISSAGGI OPZIONALI

art. P4083 Supporto a parete 3 cm

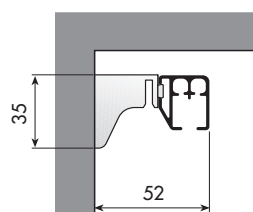

art. P4084 Supporto a parete 5 cm

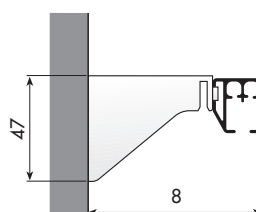

art. P4085 Supporto a parete 7 cm

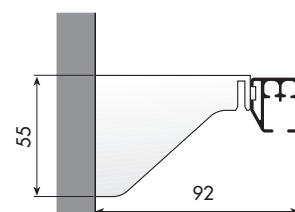

FISSAGGI OPZIONALI

art. P4142 Supporto a parete regolabile

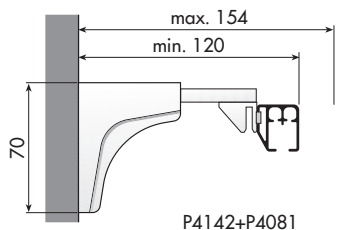

art. P4142 Supporto a parete regolabile

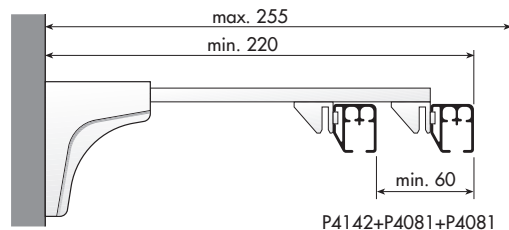

PORTATA TENDA

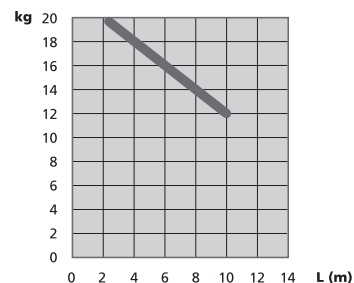

SCORREVOLI

art. P4263 Scivolo in materozza



art. P4550 Scivolo rotante



art. P4144 Scorrevole a rulli



art. P5018 Scorrevole a rulli grandi



SISTEMAZIONI

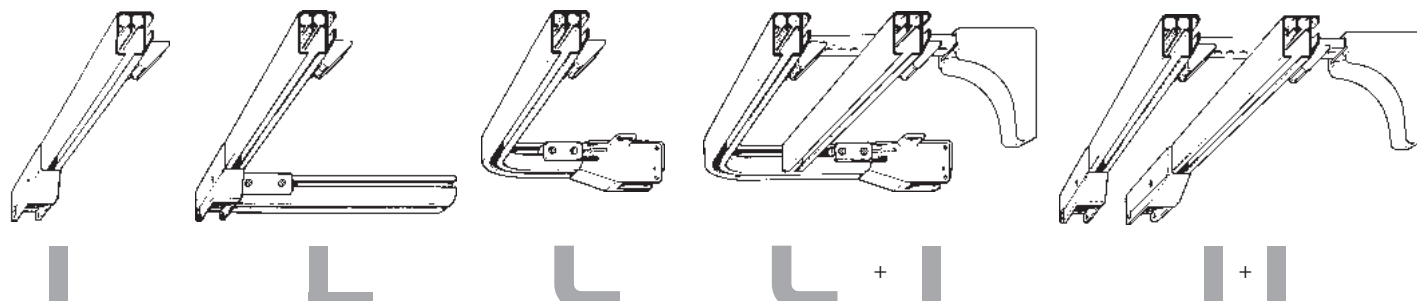

SUPPLEMENTI A RICHIESTA

| | art. | desc. | colore | euro |
|--------------------------|-------|--------------------|--------|------|
| Supporti a parete 5,5 cm | P4084 | cad. | | 3,97 |
| Supporti a parete 7,0 cm | P4085 | cad. | | 4,22 |
| Curva 90° | | cad. min. 20/21 cm | | 7,73 |
| Angolo 90° | | cad. | | 3,81 |

P490/2

| LUNGHEZZA | 140 | 160 | 180 | 200 | 220 | 240 | 260 | 280 | 300 | 320 | 340 | 360 | 380 | 400 |
|------------------|--------|--------|--------|--------|--------|--------|--------|--------|--------|--------|--------|--------|--------|--------|
| PREZZO con CORDA | 119,46 | 126,18 | 134,93 | 144,05 | 152,96 | 161,61 | 173,25 | 179,63 | 188,59 | 197,25 | 206,31 | 215,42 | 226,60 | 234,48 |
| PREZZO a STRAPPO | 68,80 | 78,64 | 88,43 | 98,26 | 108,10 | 117,94 | 127,72 | 137,56 | 147,39 | 157,23 | 167,07 | 176,85 | 186,69 | 196,52 |

| LUNGHEZZA | 420 | 440 | 460 | 480 | 500 | 520 | 540 | 560 | 580 | 600 |
|------------------|--------|--------|--------|--------|--------|--------|--------|--------|--------|--------|
| PREZZO con CORDA | 242,20 | 251,01 | 260,54 | 269,09 | 277,74 | 286,65 | 295,71 | 304,67 | 313,38 | 322,44 |
| PREZZO a STRAPPO | 206,36 | 216,20 | 226,03 | 235,87 | 245,66 | 255,48 | 265,33 | 275,16 | 284,95 | 294,79 |

PROFILO ALLUMINIO 22X24 mm



| art. | imballo | colore | euro |
|------|---------|--------|-------|
| P490 | 72 m | bianco | 20,79 |

*lunghezza aste 6 m

COPPIA CARRUCOLA

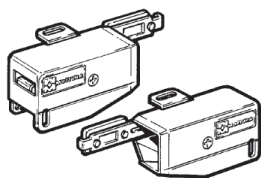

| art. | imballo | colore | euro |
|-------|---------|--------|-------|
| P4580 | 20 pz. | bianco | 21,43 |

COPPIA FISSA CORDONI

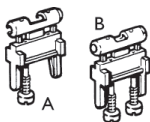

| art. | imballo | colore | euro |
|-------|---------|--------|------|
| P4586 | 50 pz. | | 2,84 |

COPPIA FISSA CORDONI

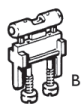

| art. | imballo | colore | euro |
|-------|---------|--------|------|
| P4588 | 100 pz. | | 1,69 |

CORDA 100% NYLON Ø 3,5 mm



| art. | imballo | colore | euro |
|-------|---------|--------|--------|
| P4188 | 400 m | bianco | 103,70 |

COPPIA GIROTENDA

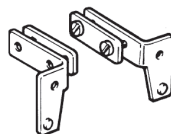

| art. | imballo | colore | euro |
|-------|---------|--------|------|
| P4439 | 20 | | 5,55 |

SORMONTO IN PLASTICA

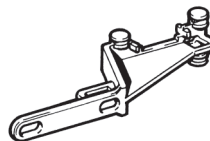

| art. | imballo | colore | euro |
|-------|---------|--------|------|
| P4185 | 100 pz. | | 2,94 |

SORMONTO IN PLASTICA 7 cm

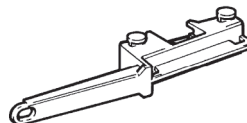

| art. | imballo | colore | euro |
|-------|---------|--------|------|
| P4585 | 50 pz. | | 3,35 |

CARRELLO GUIDATIRO

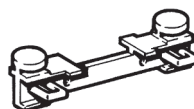

| art. | imballo | colore | euro |
|-------|---------|--------|------|
| P4182 | 50 pz. | | 1,91 |

CARRELLO GUIDA TIRO CON RUOTE

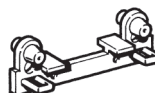

| art. | imballo | colore | euro |
|-------|---------|--------|-----------|
| P4181 | 50 pz. | | 3,62 cad. |

ASTA DI SORMONTO



| art. | imballo | colore | euro |
|-------|---------|--------|------|
| P4184 | 50 pz. | | 2,78 |

TAPPO TERMINALE

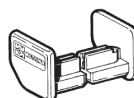

| art. | imballo | colore | euro |
|-------|---------|--------|-----------|
| P4591 | 50 pz. | bianco | 2,76 cad. |

SUPPORTO A SOFFITTO

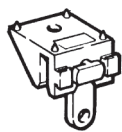

| art. | imballo | colore | euro |
|-------|---------|--------|------|
| P4081 | 100 pz. | | 2,21 |

SUPPORTO A PARETE 3 cm

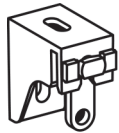

| art. | imballo | colore | euro |
|-------|---------|--------|------|
| P4083 | 100 pz. | | 2,78 |

SUPPORTO A PARETE 5,5 cm

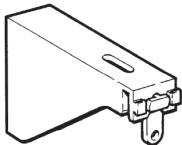

| art. | imballo | colore | euro |
|-------|---------|--------|------|
| P4084 | 50 pz. | | 3,97 |

SUPPORTO A PARETE 7,0 cm

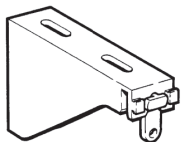

| art. | imballo | colore | euro |
|-------|---------|--------|------|
| P4085 | 50 pz. | | 4,22 |

MENSOLA A PARETE REGOLABILE

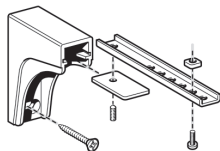

| art. | sporgenza | imballo | euro |
|-------|-----------|---------|------|
| P4142 | 10-15 cm | 10 pz. | 5,10 |
| P4142 | 16-20 cm | 10 pz. | 5,67 |
| P4142 | 21-25 cm | 10 pz. | 6,03 |

ARRESTO GIREVOLE



| art. | imballo | colore | euro |
|-------|---------|--------|------|
| P4277 | 100 pz. | | 1,00 |

FIOCCO UNIVERSALE 60g



| art. | imballo | colore | euro |
|-------|---------|--------|-----------|
| P1580 | 25 pz. | bianco | 2,38 cad. |

TENDICORDA DI SICUREZZA



| art. | imballo | colore | euro |
|-------|---------|--------|------|
| P3636 | 50 pz. | bianco | 3,15 |

SCIVOLO IN MATEROZZA



| art. | imballo | colore | euro |
|-------|----------|--------|-------|
| P4263 | 1000 pz. | | 8,09' |

*prezzo per 100 pz.

SCIVOLO ROTANTE



| art. | imballo | colore | euro |
|-------|---------|--------|--------|
| P4550 | 500 pz. | | *16,12 |

*prezzo per 100 pz.

SCORREVOLE A RULLI



| art. | imballo | colore | euro |
|-------|---------|--------|--------|
| P4144 | 500 pz. | | 51,27' |

*prezzo per 100 pz.

SCORREVOLE A RULLI GRANDI



| art. | imballo | colore | euro |
|-------|---------|--------|-----------|
| P5018 | 200 pz. | | 1,56 cad. |

CONGIUNZIONE PER PROFILO

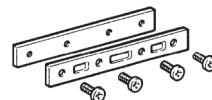

| art. | imballo | colore | euro |
|-------|---------|--------|------|
| P4589 | 10 pz. | | 7,71 |

TIRANTE IN ALLUMINIO 120 cm

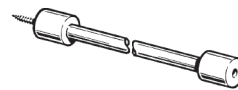

| art. | imballo | colore | euro |
|-------|---------|---------|-------|
| P4135 | 1 pz. | argento | 49,23 |

COPPIA STAFFE LATERALI A PARETE



| art. | imballo | colore | euro |
|-------|---------|--------|------|
| P4440 | 20 pz. | | 6,49 |

CARRUCOLA INTERMEDIA

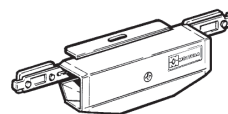

| art. | imballo | colore | euro |
|-------|---------|--------|-------|
| P4590 | 4 pz. | bianco | 31,82 |

P421

SISTEMA ULTRAPIATTO PER TENDE ARRICCIATE
LEGGERE MEDIE - INSTALLAZIONE A SOFFITTO



Dimensione profilo
L 30 mm
A 10 mm

Scala 1:1

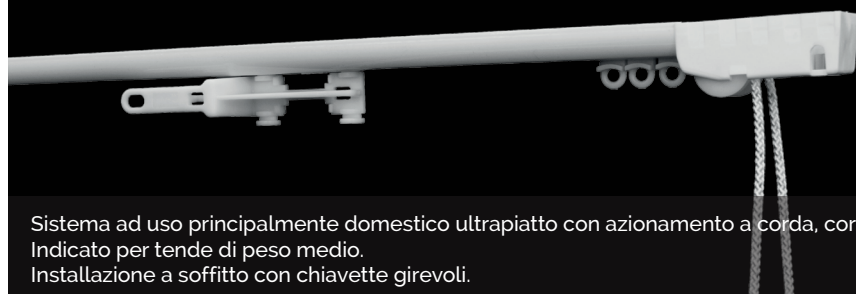

Confezione standard con:

- art. P421/... - Profilo alluminio bianco
- art. P4491 - Carrucole
- art. P4393 - Corda (Caduta 225 cm)
- art. P4391 - Fissacorda
- art. P4161 - Chiavette a soffitto
- art. P4263 - Scivoli ogni 8-10 cm
- art. P4185 - Carrello di sormonto

Sistema ad uso principalmente domestico ultrapiatto con azionamento a corda, corde guidate.
Indicato per tende di peso medio.
Installazione a soffitto con chiavette girevoli.

FISSAGGIO

SUPPORTI

art. P4161 Supporto a soffitto

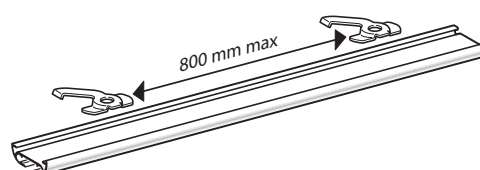
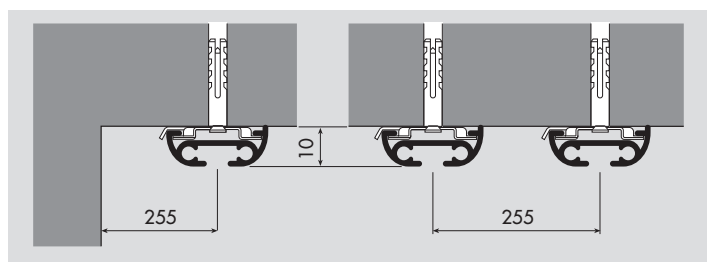

| L cm | |
|-----------|---|
| 140 | 1 |
| 141 → 200 | 2 |
| 201 → 280 | 3 |
| 281 → 340 | 4 |
| 341 → 480 | 5 |
| 481 → 600 | 6 |

SCORREVOLI

PORTATA TENDA

art. P4263 Scivolo in materozza

art. P4550 Scivolo rotante

art. P4261 Scorrevole a rulli



Con Profilo a vista +30%

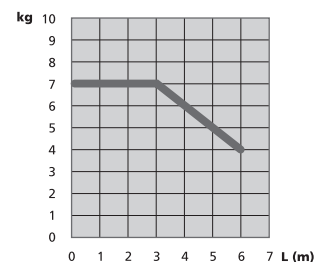

SISTEMAZIONI

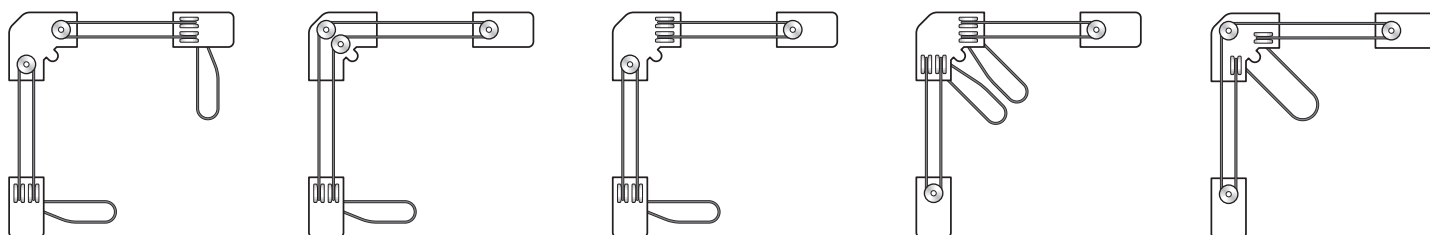

SUPPLEMENTI A RICHIESTA

| | art. | desc. | colore | euro |
|-----------------|------|-------|--------|-------|
| Angolo 90° | | cad. | | 4,58 |
| Scivolo a rullo | | al m | | 12,36 |

P421

| | | | | | | | | | | | | | | |
|------------------|--------|--------|--------|--------|--------|--------|--------|--------|--------|--------|--------|--------|--------|--------|
| LUNGHEZZA | 140 | 160 | 180 | 200 | 220 | 240 | 260 | 280 | 300 | 320 | 340 | 360 | 380 | 400 |
| PREZZO con CORDA | 65,35 | 67,88 | 71,64 | 74,16 | 76,68 | 80,44 | 85,44 | 91,10 | 95,53 | 100,53 | 106,81 | 113,09 | 125,66 | 133,23 |
| PREZZO a STRAPPO | 42,23 | 48,26 | 54,28 | 60,31 | 66,38 | 72,41 | 78,41 | 84,46 | 90,49 | 96,51 | 102,54 | 108,57 | 114,60 | 120,61 |
| LUNGHEZZA | 420 | 440 | 460 | 480 | 500 | 520 | 540 | 560 | 580 | 600 | | | | |
| PREZZO con CORDA | 141,11 | 149,56 | 155,84 | 163,36 | 163,36 | 168,41 | 170,93 | 173,97 | 176,13 | 183,34 | | | | |
| PREZZO a STRAPPO | 125,97 | 132,72 | 138,74 | 144,77 | 150,79 | 156,82 | 162,84 | 168,87 | 174,89 | 180,25 | | | | |

PROFILO ALLUMINIO 30X10 mm

| art. | imballo | colore | euro |
|------|---------|--------|-------|
| P421 | 72 m | bianco | 20,01 |



*lunghezza aste 6 m

COPPIA CARRUCOLE

| art. | imballo | colore | euro |
|-------|---------|--------|------------|
| P4491 | 20 pz. | bianco | 14,98 cad. |

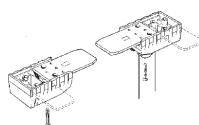

CARRUCOLA AD ANGOLO

| art. | imballo | colore | euro |
|-------|---------|--------|------------|
| P4496 | 20 pz. | bianco | 10,38 cad. |



FISSACORDA PER AGO

| art. | imballo | colore | euro |
|-------|---------|--------|-----------|
| P4391 | 100 pz. | | 1,79 cad. |



COPPIA FISSA CORDONI

| art. | imballo | colore | euro |
|-------|----------|--------|------|
| P4392 | 1 coppia | | 4,22 |



FISSACORDONE AMOVIBILE

| art. | imballo | colore | euro |
|-------|---------|--------|-----------|
| P4394 | 100 | | 2,29 cad. |

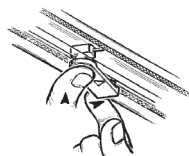

SORMONTO IN PLASTICA 7 cm

| art. | imballo | colore | euro |
|-------|---------|--------|------|
| P4585 | 50 pz. | | 3,35 |

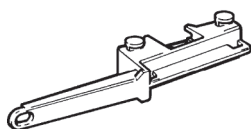

SORMONTO IN PLASTICA

| art. | imballo | colore | euro |
|-------|---------|--------|------|
| P4185 | 100 pz. | | 2,94 |

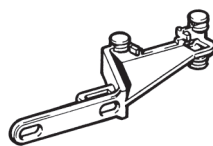

CARRELLO GUIDATIRO

| art. | imballo | colore | euro |
|-------|---------|--------|------|
| P4182 | 50 pz. | | 1,91 |

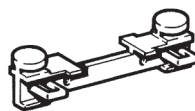

ASTA DI SORMONTO

| art. | imballo | colore | euro |
|-------|---------|--------|------|
| P4184 | 50 pz. | | 2,78 |



SCIVOLO IN MATEROZZA

| art. | imballo | colore | euro |
|-------|----------|--------|-------|
| P4263 | 1000 pz. | | 8,09* |



*prezzo per 100 pz.

SCIVOLO ROTANTE

| art. | imballo | colore | euro |
|-------|---------|--------|--------|
| P4550 | 500 pz. | | *16,12 |



*prezzo per 100 pz.

SCORREVOLE A RULLI

| art. | imballo | colore | euro |
|-------|---------|--------|------|
| P4261 | 500 pz. | | 1,30 |



ARRESTO GIREVOLE

| art. | imballo | colore | euro |
|-------|---------|--------|------|
| P4277 | 100 pz. | | 1,00 |



TAPPO TERMINALE

| art. | imballo | colore | euro |
|-------|---------|--------|----------|
| P4481 | 50 pz. | bianco | 1,35 cad |



CHIAVETTA GIREVOLE CON RONDELLA



| art. | imballo | colore | euro |
|-------|---------|--------|-----------|
| P4161 | 100 pz. | | 1,18 cad. |

CONGIUNZIONE PROFILO

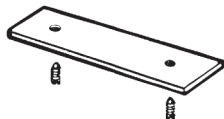

| art. | imballo | colore | euro |
|-------|---------|--------|------|
| P4098 | 10 pz. | | 4,60 |

TENDICORDA DI SICUREZZA



| art. | imballo | colore | euro |
|-------|---------|--------|------|
| P3636 | 50 pz. | bianco | 3,15 |

FIOCCO UNIVERSALE 60g



| art. | imballo | colore | euro |
|-------|---------|--------|-----------|
| P1580 | 25 pz. | bianco | 2,38 cad. |

P311



Dimensione profilo
L 25 mm
A 7 mm

Scala 1:1

SISTEMA ULTRAPIATTO MONOCANALE PER TENDE ARRICCIATE
AD USO PRINCIPALMENTE DOMESTICO



Confezione standard con:

- art. P311/. - Profilo alluminio bianco
- art. P4384 - Carrucole
- art. P4393 - Corda (Caduta 225 cm)
- art. P4391 - Fissacordoni
- art. P4585 - Sormonto
- art. P4263 - Scivoli

Sistema ultrapiatto ad uso principalmente domestico. Curvabile ad arco anche per tende multiple. Profilo preforato. Corde guidate. Indicato per tende medie. Applicazione a soffitto e sotto assicella.

FISSAGGIO

art. P4388 Supporto a soffitto

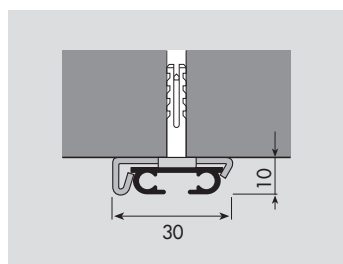

art. P4298 Fissaggio supporto ligneo

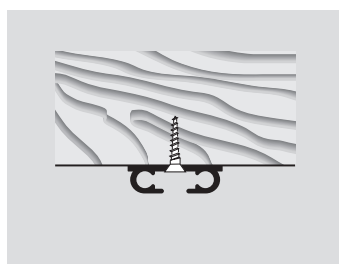

POSA IN PARALLELO

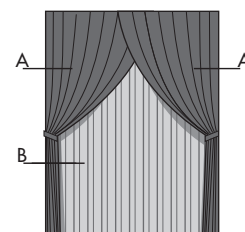
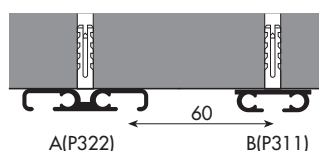

SCORREVOLI

art. P4263 Scivolo in materozza



art. P4261 Scorrevole a rulli



CURVE

Il sistema può essere curvato ad arco in sede di posa in opera



PORTATA TENDA

Con Profilo a vista +30%

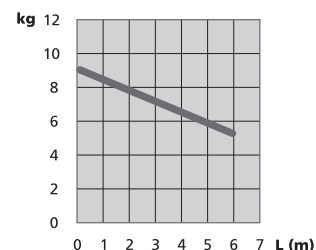

SISTEMAZIONI

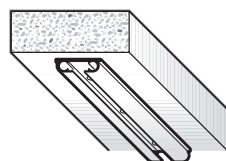

Direttamente a soffitto

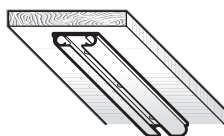

Sotto assicella di legno

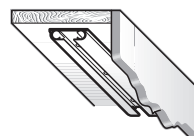

Sotto mantovana di legno



Sotto asse con Velcro®

SUPPLEMENTI A RICHIESTA

| | art. | desc. | colore | euro |
|---|-------|-------|--------|-------|
| Supporti a scatto per fissaggi a soffitto con tassello e vite | P4388 | cad. | | 2,53 |
| Scivolo a rullo | | al m | | 12,36 |

P311

| | | | | | | | | | | | | | | |
|------------------|--------|--------|--------|--------|--------|--------|--------|--------|--------|--------|--------|--------|--------|--------|
| LUNGHEZZA | 140 | 160 | 180 | 200 | 220 | 240 | 260 | 280 | 300 | 320 | 340 | 360 | 380 | 400 |
| PREZZO con CORDA | 57,86 | 62,87 | 68,41 | 74,21 | 78,56 | 84,37 | 89,52 | 94,40 | 99,54 | 105,35 | 110,72 | 118,17 | 123,60 | 128,85 |
| PREZZO a STRAPPO | 36,85 | 42,10 | 47,36 | 52,63 | 57,89 | 63,15 | 68,41 | 73,68 | 84,20 | 89,47 | 91,72 | 94,73 | 99,99 | 105,25 |
| LUNGHEZZA | 420 | 440 | 460 | 480 | 500 | 520 | 540 | 560 | 580 | 600 | | | | |
| PREZZO con CORDA | 133,47 | 139,27 | 144,26 | 149,98 | 155,53 | 160,78 | 166,06 | 171,62 | 175,16 | 178,44 | | | | |
| PREZZO a STRAPPO | 110,52 | 115,78 | 121,05 | 126,29 | 131,56 | 136,83 | 142,09 | 147,35 | 152,62 | 157,88 | | | | |

PROFILO ALLUMINIO 25X7 mm

| art. | imballo | colore | euro |
|------|---------|--------|-------|
| P311 | 60 m | bianco | 14,94 |



*lunghezza aste 6 m

COPPIA CARRUCOLE

| art. | imballo | colore | euro |
|-------|---------|--------|------------|
| P4384 | 30 pz. | bianco | 10,23 cad. |

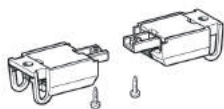

SUPPORTO A SCATTO IN ACCIAIO

| art. | imballo | colore | euro |
|-------|---------|--------|-----------|
| P4388 | 50 pz. | | 1,29 cad. |



VITE FISSAGGIO A LEGNO

| art. | imballo | colore | euro |
|-------|---------|--------|--------|
| P4298 | 500 pz. | | 1,29 * |



*prezzo per 100 pz.

SORMONTO IN PLASTICA

| art. | imballo | colore | euro |
|-------|---------|--------|------|
| P4185 | 100 pz. | | 2,94 |

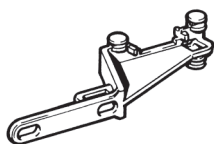

SORMONTO IN PLASTICA 7 cm

| art. | imballo | colore | euro |
|-------|---------|--------|------|
| P4585 | 50 pz. | | 3,35 |

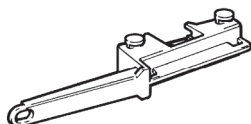

ARRESTO GIREVOLE

| art. | imballo | colore | euro |
|-------|---------|--------|------|
| P4277 | 100 pz. | | 1,00 |



SCIVOLO IN MATEROZZA

| art. | imballo | colore | euro |
|-------|----------|--------|--------|
| P4263 | 1000 pz. | | 8,09 * |



*prezzo per 100 pz.

SCORREVOLE A RULLI

| art. | imballo | colore | euro |
|-------|---------|--------|------|
| P4261 | 500 pz. | | 1,30 |



CORDA 100% NYLON Ø 3 mm

| art. | imballo | colore | euro |
|-------|---------|--------|--------|
| P4393 | 500 m | bianco | 106,81 |



FISSACORDA PER AGO

| art. | imballo | colore | euro |
|-------|---------|--------|-----------|
| P4391 | 100 pz. | | 1,79 cad. |



COPPIA FISSA CORDONI

| art. | imballo | colore | euro |
|-------|----------|--------|------|
| P4392 | 1 coppia | | 4,22 |



FISSACORDONE AMOVIBILE

| art. | imballo | colore | euro |
|-------|---------|--------|-----------|
| P4394 | 100 | | 2,29 cad. |

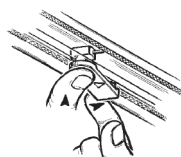

TENDICORDA DI SICUREZZA

| art. | imballo | colore | euro |
|-------|---------|--------|------|
| P3636 | 50 pz. | bianco | 3,15 |



FIOCCO UNIVERSALE 60g

| art. | imballo | colore | euro |
|-------|---------|--------|-----------|
| P1580 | 25 pz. | bianco | 2,38 cad. |



P322



Dimensione profilo
L 25 mm
A 7 mm

Scala 1:1

SISTEMA ULTRAPIATTO A DOPPIO CANALE PER
TENDE ARRICCIATE A GRANDE SORMONTO



Confezione standard con:

- art. P322/... - Profilo alluminio bianco
- art. P4395 - Carrucole
- art. P4393 - Corda (Caduta 225 cm)
- art. P4391 - Fissacordoni
- art. P4585 - Sormonto
- art. P4263 - Scivoli

Sistema ultrapiatto ad uso principalmente domestico. Curvabile ad arco anche per tende e sovratende ad ampio sormonto. Profilo perforato. Corde guidate. Indicato per tende medie. Applicazione a soffitto e sotto assicella.

FISSAGGIO

art. P322 Supporto a soffitto

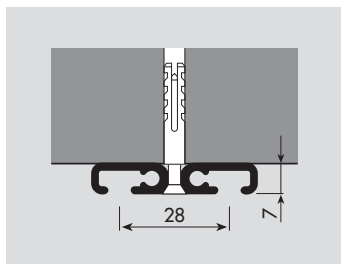

art. P4399 Fissaggio a supporto ligneo

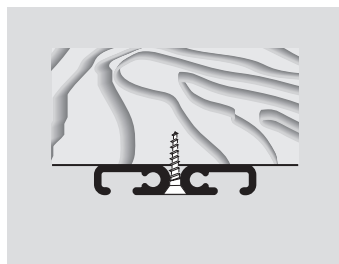

POSA IN PARALLELO

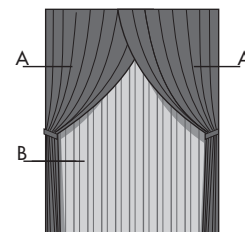
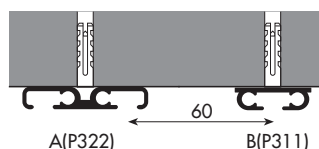

SCORREVOLI

art. P4263 Scivolo in materozza



art. P4261 Scorrevole a rulli



CURVE



Il sistema può essere curvato ad arco in sede di posa in opera

PORTATA TENDA

Con Profilo a vista +30%

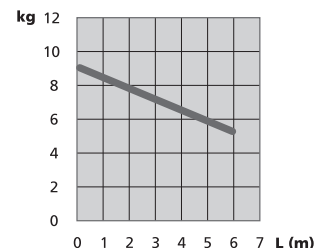

SISTEMAZIONI

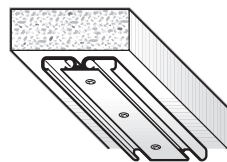

Direttamente a soffitto

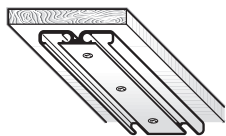

Sotto assicella di legno

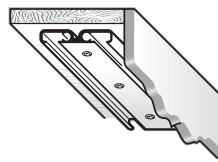

Sotto mantovana di legno



Sotto asse con Velcro®

SUPPLEMENTI A RICHIESTA

Scivolo a rullo

art.

desc.

colore

euro

al m

12,36

P322

| | | | | | | | | | | | | | | |
|------------------|--------|--------|--------|--------|--------|--------|--------|--------|--------|--------|--------|--------|--------|--------|
| LUNGHEZZA | 140 | 160 | 180 | 200 | 220 | 240 | 260 | 280 | 300 | 320 | 340 | 360 | 380 | 400 |
| PREZZO con CORDA | 66,49 | 72,62 | 79,67 | 86,31 | 92,70 | 99,91 | 106,71 | 113,35 | 120,97 | 126,95 | 133,75 | 139,05 | 147,29 | 153,83 |
| PREZZO a STRAPPO | 41,82 | 47,79 | 53,77 | 59,74 | 65,71 | 71,69 | 77,66 | 83,64 | 89,61 | 95,58 | 101,56 | 107,53 | 113,51 | 119,48 |
| LUNGHEZZA | 420 | 440 | 460 | 480 | 500 | 520 | 540 | 560 | 580 | 600 | | | | |
| PREZZO con CORDA | 160,63 | 167,84 | 174,48 | 181,18 | 187,82 | 194,62 | 201,93 | 208,06 | 215,37 | 222,07 | | | | |
| PREZZO a STRAPPO | 125,45 | 131,43 | 137,40 | 143,38 | 149,35 | 155,32 | 161,30 | 167,27 | 173,25 | 179,22 | | | | |

PROFILO ALLUMINIO 41x7mm



| art. | imballo | colore | euro |
|------|---------|--------|-------|
| P322 | 54m | bianco | 22,38 |

*lunghezza aste 6 m

COPPIA CARRUCOLE

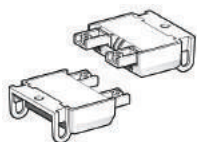

| art. | imballo | colore | euro |
|-------|---------|--------|-------|
| P4395 | 30 pz. | bianco | 11,92 |

CORDA 100% NYLON Ø 3 mm



| art. | imballo | colore | euro |
|-------|---------|--------|--------|
| P4393 | 500 m | bianco | 106,81 |

SORMONTO IN PLASTICA

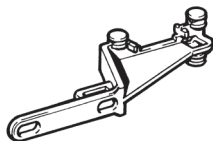

| art. | imballo | colore | euro |
|-------|---------|--------|------|
| P4185 | 100 pz. | | 2,94 |

FISSACORDA PER AGO



| art. | imballo | colore | euro |
|-------|---------|--------|-----------|
| P4391 | 100 pz. | | 1,79 cad. |

SORMONTO IN PLASTICA 7 cm

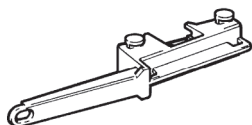

| art. | imballo | colore | euro |
|-------|---------|--------|------|
| P4585 | 50 pz. | | 3,35 |

COPPIA FISSA CORDONI



| art. | imballo | colore | euro |
|-------|----------|--------|------|
| P4392 | 1 coppia | | 4,22 |

VITE FISSAGGIO A LEGNO



| art. | imballo | colore | euro |
|-------|---------|--------|------|
| P4399 | 500 pz. | | 9,27 |

*prezzo per 100 pz.

FISSACORDONE AMOVIBILE

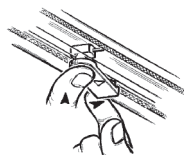

| art. | imballo | colore | euro |
|-------|---------|--------|-----------|
| P4394 | 100 | | 2,29 cad. |

ARRESTO GIREVOLE



| art. | imballo | colore | euro |
|-------|---------|--------|------|
| P4277 | 100 pz. | | 1,00 |

TENDICORDA DI SICUREZZA



| art. | imballo | colore | euro |
|-------|---------|--------|------|
| P3636 | 50 pz. | bianco | 3,15 |

SCIVOLO IN MATEROZZA



| art. | imballo | colore | euro |
|-------|----------|--------|-------|
| P4263 | 1000 pz. | | 8,09* |

*prezzo per 100 pz.

FIOCCO UNIVERSALE 60g



| art. | imballo | colore | euro |
|-------|---------|--------|-----------|
| P1580 | 25 pz. | bianco | 2,38 cad. |

SCORREVOLE A RULLI



| art. | imballo | colore | euro |
|-------|---------|--------|------|
| P4261 | 500 pz. | | 1,30 |

P324

SISTEMA A DOPPIO CANALE PER TENDE
ARRICCIATE A GRANDE SORMONTO



Dimensione profilo
L 57,8 mm
A 10 mm

Scala 1:1

Confezione standard con:

- art. P535 - Profilo alluminio bianco
- art. P4557 - Gruppo comando
- art. P4559 - Gruppo sollevamento
- art. P3281 - Alberino di comando
- art. P1839 - Catena (caduta 225 cm)



Sistema ad uso domestico o alberghiero per tende leggere ed oscuranti a grande sormonto.
Corde guidate. Scorrevoli a rullo. Applicazione a soffitto.

FISSAGGIO

art. P324 Supporto a soffitto

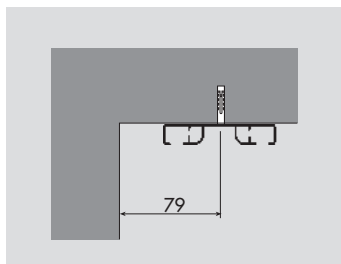

art. P324 Fissaggio a supporto ligneo

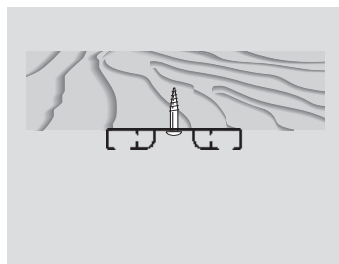

POSA IN PARALLELO

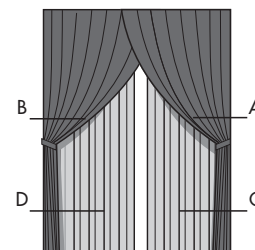
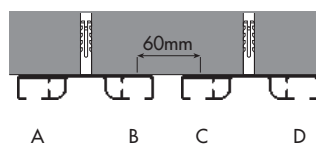

SCORREVOLI

art. P4263 Scivolo in materozza



art. P4144 Scorrevole a rulli



art. P4167 Scorrevole con occhiolo girevole



PORTATA TENDA

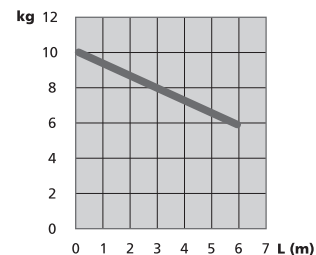

SUPPLEMENTI A RICHIESTA

Scivolo a rullo

| art. | desc. | colore | euro |
|-------|-------|--------|------|
| P4144 | al m. | | 5,67 |

P324

| | | | | | | | | | | | | | | |
|------------------|--------|--------|--------|--------|--------|--------|--------|--------|--------|--------|--------|--------|--------|--------|
| LUNGHEZZA | 140 | 160 | 180 | 200 | 220 | 240 | 260 | 280 | 300 | 320 | 340 | 360 | 380 | 400 |
| PREZZO con CORDA | 61,39 | 67,41 | 73,54 | 79,77 | 86,06 | 91,93 | 98,06 | 104,13 | 110,42 | 116,29 | 122,26 | 129,57 | 134,93 | 140,80 |
| PREZZO a STRAPPO | 38,30 | 43,80 | 49,25 | 54,20 | 60,20 | 65,65 | 71,15 | 76,60 | 82,05 | 87,55 | 93,00 | 98,50 | 103,95 | 109,40 |
| LUNGHEZZA | 420 | 440 | 460 | 480 | 500 | 520 | 540 | 560 | 580 | 600 | | | | |
| PREZZO con CORDA | 146,78 | 152,90 | 158,93 | 164,90 | 171,44 | 177,31 | 183,55 | 189,52 | 195,39 | 201,52 | | | | |
| PREZZO a STRAPPO | 114,90 | 120,35 | 125,80 | 131,80 | 136,75 | 142,25 | 147,70 | 153,20 | 158,65 | 164,10 | | | | |

PROFILO ALLUMINIO 57,8x10mm



| art. | imballo | colore | euro |
|------|---------|--------|-------|
| P324 | 54m | bianco | 21,22 |

*lunghezza aste 6 m

CARRUCOLA

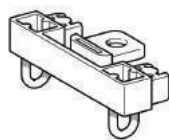

| art. | imballo | colore | euro |
|-------|---------|--------|-----------|
| P4508 | 100 pz. | bianco | 2,52 cad. |

ARRESTO GIREVOLE



| art. | imballo | colore | euro |
|-------|---------|--------|------|
| P4277 | 100 pz. | | 1,00 |

CARRUCOLA CON RUOTE

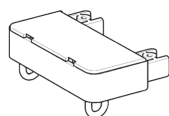

| art. | imballo | colore | euro |
|-------|---------|--------|------------|
| P4509 | 30 pz. | bianco | 11,28 cad. |

SCIVOLO IN MATEROZZA



| art. | imballo | colore | euro |
|-------|----------|--------|-------|
| P4263 | 1000 pz. | | 8,09* |

*prezzo per 100 pz.

FISSACORDONE REGOLABILE

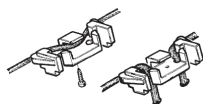

| art. | imballo | colore | euro |
|-------|---------|--------|------|
| P4482 | 50 pz. | | 3,81 |

SCORREVOLE A RULLI



| art. | imballo | colore | euro |
|-------|---------|--------|--------|
| P4144 | 500 pz. | | 51,27* |

*prezzo per 100 pz.

SORMONTO IN PLASTICA

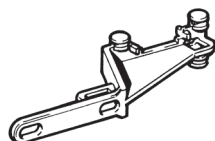

| art. | imballo | colore | euro |
|-------|---------|--------|------|
| P4185 | 100 pz. | | 2,94 |

SCORREVOLE CON OCCHIOLO GIREVOLE



| art. | imballo | colore | euro |
|-------|---------|--------|-----------|
| P4167 | 250 pz. | | 1,60 cad. |

CORDA 100% NYLON Ø 3 mm



| art. | imballo | colore | euro |
|-------|---------|--------|--------|
| P4393 | 500 m | bianco | 106,81 |

P939

SISTEMA DI TRASLAZIONE VERTICALE PER TENDE ARRICCIATE ED A PACCHETTO

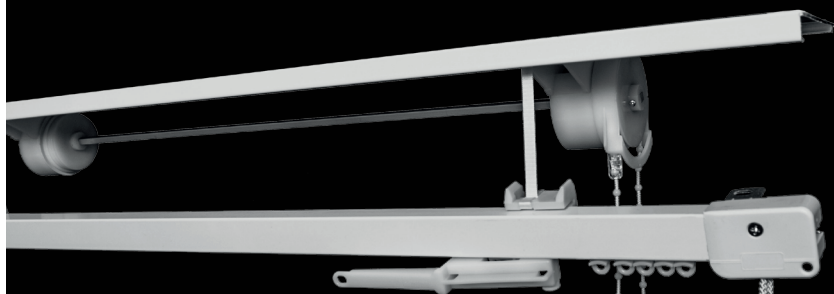

Confezione standard con:

- art. P535 - Profilo alluminio bianco
- art. P4557 - Gruppo comando
- art. P4559 - Gruppo sollevamento
- art. P3281 - Alberino di comando
- art. P1839 - Catena (caduta 225 cm)

Abbinabile a

- P430 - P470
- P470/2 - P490
- P412 - P444/2
- P444/3 - P414

Installazione a soffitto o a parete. Solo per sistemi diritti. Angolo fisso 13 cm max.

FISSAGGIO

art. P535 Supporto a soffitto

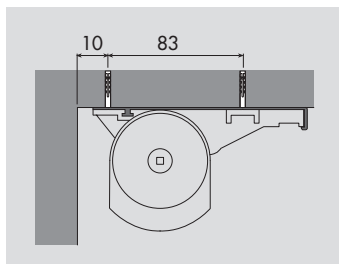

art. P4560 Fissaggio a parete

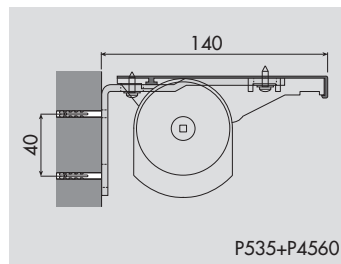

P535+P4560

SISTEMAZIONE

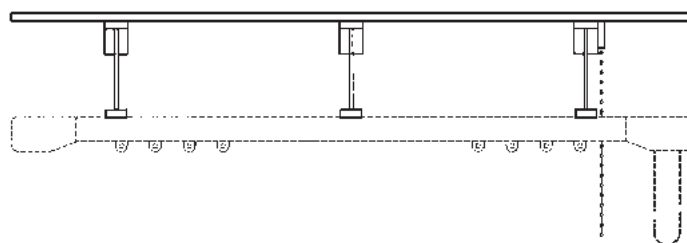

PORTATA

2 rocchetti - 3,5 kg max

3 rocchetti - 6 kg max

4 rocchetti - 8 kg max

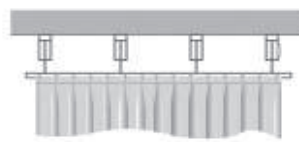
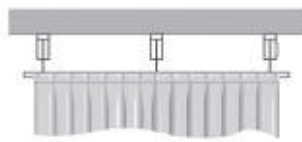

P939

| | | | | | |
|------------------|--------|--------|--------|--------|--------|
| LUNGHEZZA | 150 | 180 | 210 | 250 | 300 |
| NUMERO ROCCHETTI | 2 | 2 | 3 | 3 | 4 |
| PREZZO | 212,30 | 226,95 | 276,95 | 296,95 | 377,10 |

GRUPPO COMANDO E SOLLEVAMENTO

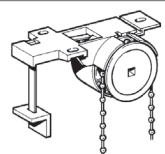

| art. | imballo | colore | euro |
|-------|---------|--------|-------|
| P4557 | 10 pz. | | 63,63 |

ROCCHETTO DI SOLLEVAMENTO

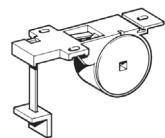

| art. | imballo | colore | euro |
|-------|---------|--------|-------|
| P4559 | 10 pz. | | 62,03 |

ALBERINO DI COMANDO 5mm

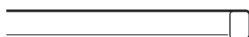

| art. | imballo | colore | euro |
|-------|---------|--------------------|------|
| P3281 | 90m | argento/ grigio | 6,66 |

Lunghezza aste 4,5 m

CATENELLA PASSO 12 mm

| art. | imballo | colore | euro |
|-------|---------|--------|-----------|
| P1839 | 250m | bianco | 2,29 al m |



GIUNTO PER CATENELLA

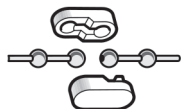

| art. | imballo | colore | euro |
|-------|---------|--------|-----------|
| P3641 | 200 pz. | | 0,55 cad. |

ANELLO CATENA CONTINUO



| art. | imballo | cm | euro |
|----------|---------|-----|-------|
| P3274/20 | 15 pz. | 200 | 12,79 |
| P3274/25 | 15 pz. | 250 | 13,80 |
| P3274/30 | 15 pz. | 300 | 14,63 |
| P3274/35 | 15 pz. | 350 | 15,74 |
| P3274/40 | 15 pz. | 400 | 16,87 |
| P3274/45 | 15 pz. | 450 | 19,93 |
| P3274/50 | 15 pz. | 500 | 21,92 |
| P3274/55 | 15 pz. | 550 | 24,00 |
| P3274/60 | 15 pz. | 600 | 26,14 |
| P3274/65 | 15 pz. | 700 | 29,53 |

TENDICORDA DI SICUREZZA



| art. | imballo | colore | euro |
|-------|---------|--------|------|
| P3636 | 50 pz. | bianco | 3,15 |

PROFILO DI SOSTEGNO

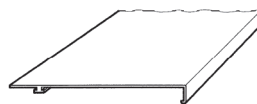

| art. | imballo | colore | euro |
|------|---------|--------|-------|
| P535 | 36 m | bianco | 32,29 |

lunghezza aste 6m

MENSOLA A PARETE

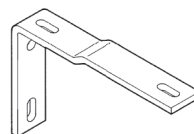

| art. | imballo | colore | euro |
|-------|---------|--------|------|
| P4560 | 12 pz. | bianco | 8,42 |

P202

SISTEMA PER TENDE ARRICCIATE PESANTI



Dimensione profilo
L 27,4 mm
A 36 mm

Scala 1:2



Confezione standard con:

- art. P202 - Profilo alluminio bianco
- art. P5079 - Carrucole
- art. P5083 - Corda (Caduta 225 cm)
- art. P5082 - Fissacordoni
- art. P5540 - Sormonto
- art. P5018 - Scorrevoli (P5028 oltre 7 m)
- art. P5234 - Chiavette

Sistema curvabile indicato per grandi ambienti o sipari. Corde guidate. Scorrevoli con cuscinetti a sfere. Indicato per tende molto pesanti. Applicazione a soffitto e a parete.

FISSAGGIO

art. P5234 Fissaggio a soffitto

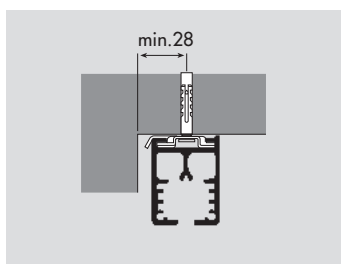

art. P4142 Fissaggio a parete

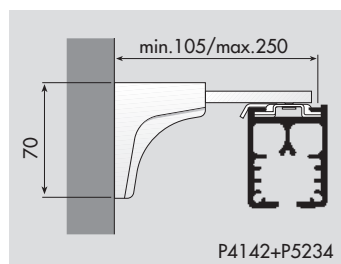

PORTATA

LE PORTATE SI RIFERISCONO CON PROFILO A VISTA DIRITTO E APERTURA CENTRALE

- Per profilo coperto: -20%
- Per apertura laterale: -10%
- Per una curva 90°: -30%
- Per 2 curve 90° o centinato: -70%

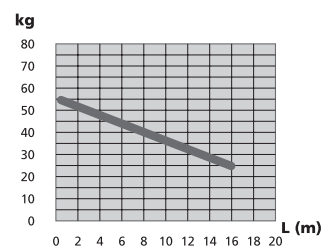

SCORREVOLI

art. P5018 Scorrevole a rulli grandi



art. P5028 Scorrevole con sfere



art. P5017 Scorrevole con occhio girevole



art. P5027 Scorrevole pivotante con sfere



SUPPLEMENTI A RICHIESTA

| | art. | desc. | colore | euro |
|-----------------------------------|-------|-------|--------|--------|
| Fiocco 650 g | P5088 | cad. | | 55,16 |
| Curva 90° oppure 45°/raggio 30 cm | P1992 | cad. | | 77,66 |
| Curve ad ampio raggio | P1993 | al m | | 118,81 |

P202

| LUNGHEZZA | 200 | 300 | 400 | 500 | 600 | 700 | 800 | 900 | 1000 |
|------------------|--------|--------|--------|--------|--------|--------|--------|---------|---------|
| PREZZO con CORDA | 297,46 | 365,08 | 434,15 | 498,06 | 744,38 | 901,82 | 999,15 | 1108,80 | 1179,97 |
| PREZZO a STRAPPO | 132,05 | 198,07 | 264,09 | 330,12 | 396,14 | 734,18 | 838,83 | 943,69 | 1031,85 |

PROFILO ALLUMINIO 27,4 x 36 mm



| art. | imballo | colore | euro |
|------|---------|--------|-------|
| P202 | 36 m | bianco | 37,55 |

Lunghezza aste 6 m

COPPIA CARRUCOLE

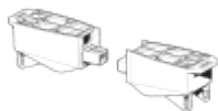

| art. | imballo | colore | euro |
|-------|---------|--------|-------|
| P5079 | 6 cp. | bianco | 43,93 |

FISSACORDA

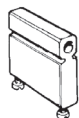

| art. | imballo | colore | euro |
|-------|---------|--------|------|
| P5082 | 10 pz. | | 8,64 |

SCORREVOLE A RULLI GRANDI



| art. | imballo | colore | euro |
|-------|---------|--------|----------|
| P5018 | 200 pz. | | 156 cad. |

SCORREVOLE CON SFERE



| art. | imballo | colore | euro |
|-------|---------|--------|-----------|
| P5028 | 200 pz. | | 4,60 cad. |

CHIAVETTA GIREVOLE



| art. | imballo | colore | euro |
|-------|---------|--------|--------|
| P5234 | 100 pz. | | 2,51 * |

*prezzo per 100 pz.

MENSOLA A PARETE REGOLABILE

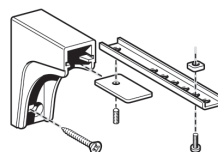

| art. | sporgenza | imballo | euro |
|-------|-----------|---------|------|
| P4142 | 10-15 cm | 10 pz. | 5,10 |
| P4142 | 16-20 cm | 10 pz. | 5,67 |
| P4142 | 21-25 cm | 10 pz. | 6,03 |

CONGIUNZIONE PROFILO

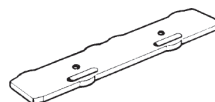

| art. | imballo | colore | euro |
|-------|---------|--------|------|
| P5229 | 10 pz. | | 7,78 |

ASTA DI SORMONTO

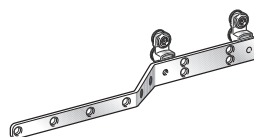

| art. | imballo | colore | euro |
|-------|---------|--------|-------|
| P5540 | 1 pz. | | 28,33 |

TENDICORDA 650 g



| art. | imballo | colore | euro |
|-------|---------|--------|-------|
| P5088 | 2 pz. | bianco | 55,16 |

P541

SISTEMA CURVABILE A MOTORE PER TENDE
ARRICCIAIE MEDIO/LEGGERE



Dimensione profilo
L 29,2 mm
A 20,4 mm

Scala 1:1

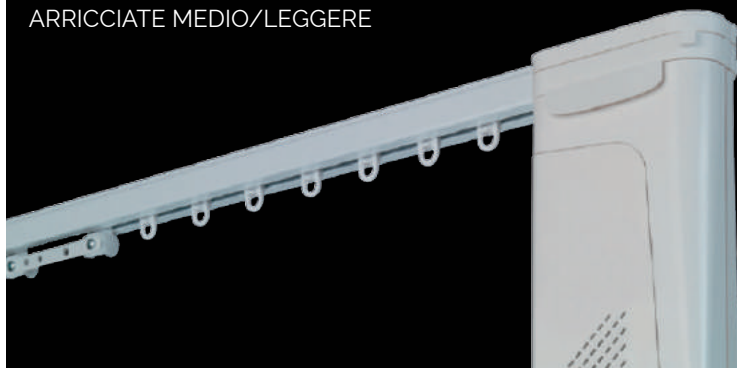

Confezione standard con:

- art. P541 - Profilo alluminio bianco
- art. P5534 - Cinghia di trasmissione
- art. P5580 - Carrucola motore
- art. P5581 - Carrucola rinvio
- art. P5582 / P5584 - Motore digitale
- art. P5585 - Aggancio nastro
- art. P5590 - Asta di sormonto
- art. P4167 - Scorrevoli con occhiolo girevole
- art. P5234 - Chiavetta di fissaggio

Sistema indicato per tendaggi ad uso domestico/professionale. Curvabile a 90° ed ampio raggio. Motore 230Vac. Finecorsa elettronico automatico. Velocità di scorrimento: 12 cm/s. Installazione: parete/soffitto. Alimentazione: 230Vac.

FISSAGGIO

art. P5234 Fissaggio a soffitto

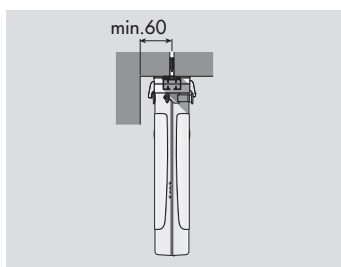

art. P5234 Fissaggio a soffitto

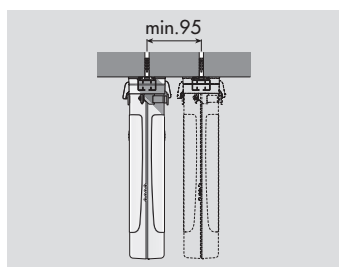

art. P4142 Fissaggio a parete

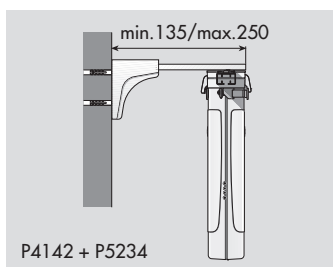

POSA IN PARALLELO

In presenza di sipari si consiglia l'utilizzo di 2 sistemi P541 in parallelo azionati da un solo pulsante (P5461/P5096)

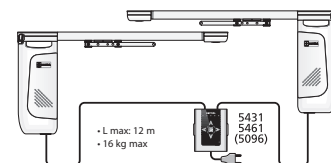

SCORREVOLI

art. P4263 Scivolo in materozza



P4263

art. P4144 Scorrevole a rulli



P4144

art. P5018 Scorrevole a rulli grandi



P5018

art. P4431 Scorrevole a rulli Noise Soft®



P4431

art. P4167 Scorrevole con occhiolo girevole



P4167

art. P5017 Scorrevole con occhiolo girevole



P5017

CURVE

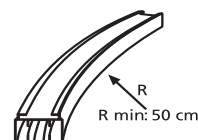
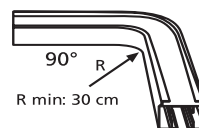

PORTATA

| POWER 541/1 | 1m | 2m | 3m | 4m | 5m | 6m |
|-------------|-------|-------|-------|-------|-------|-------|
| A | 12 Kg | 12 Kg | 18 Kg | 18 Kg | 12 Kg | 12 Kg |
| B | 12 Kg | 12 Kg | 18 Kg | 18 Kg | 12 Kg | 12 Kg |
| C | 10 Kg | 10 Kg | 12 Kg | 12 Kg | 12 Kg | 12 Kg |
| D | 10 Kg | 10 Kg | 12 Kg | 12 Kg | 10 Kg | 8 Kg |
| E | 5 Kg | 5 Kg | 7 Kg | 7 Kg | 10 Kg | 8 Kg |
| F | 5 Kg | 5 Kg | 7 Kg | 7 Kg | 6 Kg | 5 Kg |
| G | 5 Kg | 5 Kg | 7 Kg | 7 Kg | 6 Kg | 5 Kg |
| H | 5 Kg | 5 Kg | 7 Kg | 7 Kg | 6 Kg | 5 Kg |

| POWER 541/2 | 2m | 4m | 6m | 8m | 10m | 12m |
|-------------|-------|-------|-------|-------|-------|-------|
| A | 15 Kg | 28 Kg | 28 Kg | 24 Kg | 20 Kg | 18 Kg |
| B | 15 Kg | 28 Kg | 28 Kg | 24 Kg | 20 Kg | 18 Kg |
| C | 12 Kg | 22 Kg | 22 Kg | 17 Kg | 15 Kg | 12 Kg |
| D | 12 Kg | 22 Kg | 22 Kg | 17 Kg | 15 Kg | 12 Kg |
| E | 6 Kg | 6 Kg | 12 Kg | 10 Kg | 8 Kg | 7 Kg |
| F | 6 Kg | 6 Kg | 12 Kg | 10 Kg | 8 Kg | 7 Kg |
| G | 6 Kg | 6 Kg | 12 Kg | 10 Kg | 8 Kg | 7 Kg |
| H | 6 Kg | 6 Kg | 12 Kg | 10 Kg | 8 Kg | 7 Kg |

AUTOSTART

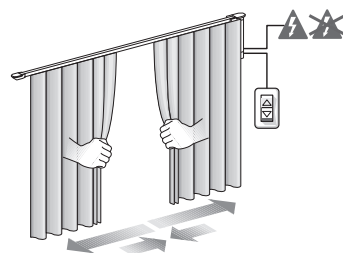

AUTOSTART® è il dispositivo elettronico che mette automaticamente in funzione il sistema in caso di azionamento da parte di utenti privi di familiarità con i sistemi motorizzati e permette anche l'apertura manuale delle tende nei casi di emergenza come la mancanza di corrente. AUTOSTART® è un dispositivo che funziona sia con sistemi ad apertura centrale che laterale.

SUPPLEMENTI A RICHIESTA

| | art. | desc. | colore | euro |
|--|-------|-------|--------|-------|
| Curva a 90° - raggio 35 cm, in aggiunta allo sviluppo totale di ogni curva | P1998 | cad. | | 50,65 |
| Curve ad ampio raggio | P1999 | cad. | | 50,65 |
| Distanziale/scivolo 60mm | P4554 | | | 9,79 |
| Distanziale/scivolo 80mm | P4554 | | | 7,07 |

P541

| LUNGHEZZA | 140 | 160 | 180 | 200 | 220 | 240 | 260 | 280 | 300 | 320 | 340 | 360 | 380 | 400 |
|---------------|----------|----------|----------|----------|----------|----------|----------|----------|----------|----------|----------|----------|----------|----------|
| PREZZO P541/1 | 1.045,30 | 1.073,19 | 1.087,22 | 1.112,09 | 1.127,62 | 1.141,65 | 1.155,53 | 1.172,72 | 1.185,08 | 1.199,11 | 1.219,30 | 1.236,35 | 1.258,06 | 1.272,08 |
| PREZZO P541/2 | 982,59 | 1.008,80 | 1.022,00 | 1.045,37 | 1.059,97 | 1.073,17 | 1.086,16 | 1.102,37 | 1.113,98 | 1.127,17 | 1.146,15 | 1.162,18 | 1.182,59 | 1.195,76 |

| LUNGHEZZA | 450 | 500 | 550 | 600 | 650 | 700 | 750 | 800 |
|---------------|----------|----------|----------|----------|----------|----------|----------|----------|
| PREZZO P541/1 | 1.321,70 | 1.390,16 | 1.458,46 | 1.529,94 | 1.604,43 | 1.637,00 | 1.661,88 | 1.699,13 |
| PREZZO P541/2 | 1.242,41 | 1.306,77 | 1.370,98 | 1.396,96 | 1.508,18 | 1.538,79 | 1.567,99 | 1.597,19 |

PROFILO ALLUMINIO 29,2 x 20,4 mm



| art. | imballo | colore | euro |
|------|---------|----------------|-------|
| P541 | 30 m | argento/grigio | 24,10 |
| P541 | 30 m | bianco | 24,10 |
| P541 | 30 m | nero | 24,10 |

*lunghezza aste 6 m

CARRUCOLA MOTORE

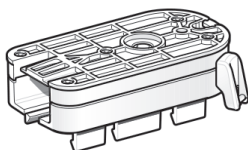

| art. | imballo | colore | euro |
|-------|---------|----------------|-------|
| P5580 | 10 pz. | argento/grigio | 18,65 |
| P5580 | 10 pz. | bianco | 18,65 |
| P5580 | 10 pz. | nero | 18,65 |

CARRUCOLA RINVIO



| art. | imballo | colore | euro |
|-------|---------|----------------|-------|
| P5581 | 10 pz. | argento/grigio | 16,44 |
| P5581 | 10 pz. | bianco | 16,44 |
| P5581 | 10 pz. | nero | 16,44 |

MOTORE DIGITALE 10 Ncm



| art. | imballo | colore | euro |
|-------|---------|--------|--------|
| P5582 | 1 pz. | bianco | 657,01 |
| P5582 | 1 pz. | nero | 657,01 |

MOTORE DIGITALE 30 Ncm



| art. | imballo | colore | euro |
|-------|---------|--------|--------|
| P5584 | 1 pz. | bianco | 689,63 |
| P5584 | 1 pz. | nero | 689,63 |

CINGHIA DENTATA DI TRASMISSIONE

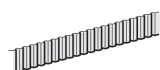

| art. | imballo | colore | euro |
|-------|---------|--------|-------|
| P5534 | 100 m. | | 20,60 |

ASTA DI SORMONTO

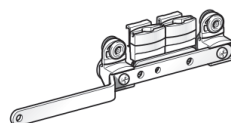

| art. | imballo | dx/sx | euro |
|-------|---------|--------|-------|
| P5590 | 10 pz. | destra | 17,10 |

AGGANCI NASTRO

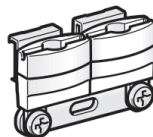

| art. | imballo | colore | euro |
|-------|---------|--------|-------|
| P5585 | 10 pz. | | 11,22 |

SCIVOLO PER TENDE A ONDA

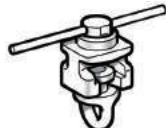

| art. | imballo | mm | euro |
|-------|---------|----|-------|
| P4554 | 25 pz. | 60 | 17,29 |
| P4554 | 25 pz. | 80 | 14,26 |

SORMONTO CENTRALE PER TENDE AD ONDA

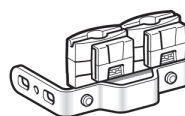

| art. | imballo | mm | euro |
|-------|---------|----|-------|
| P5591 | 10 pz. | 60 | 17,95 |
| P5592 | 10 pz. | 80 | 17,95 |

SCIVOLO IN MATEROZZA



| art. | imballo | colore | euro |
|-------|----------|--------|-------|
| P4263 | 1000 pz. | | 8,09* |

*prezzo per 100 pz.

SCORREVOLE A RULLI



| art. | imballo | colore | euro |
|-------|---------|--------|--------|
| P4144 | 500 pz. | | 51,29* |

*prezzo per 100 pz.

SCORREVOLE CON OCCHIOLO GIREVOLE



| art. | imballo | colore | euro |
|-------|---------|--------|----------|
| P4167 | 250 pz. | | 160 cad. |

SCORREVOLE A RULLI Noise Soft®



| art. | imballo | colore | euro |
|-------|---------|--------|--------|
| P4431 | 500 pz. | | 89,84* |

*prezzo per 100 pz.

SCORREVOLE A RULLI GRANDI



| art. | imballo | colore | euro |
|-------|---------|--------|----------|
| P5018 | 200 pz. | | 156 cad. |

SCORREVOLE CON OCCHIOLO GIREVOLE



| art. | imballo | colore | euro |
|-------|---------|--------|-------|
| P5017 | 200 pz. | | 2,08* |

*prezzo per 100 pz.

CONGIUNZIONE PROFILO

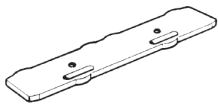

| art. | imballo | colore | euro |
|-------|---------|--------|------|
| P5229 | 10 pz. | | 7,78 |

CHIAVETTA GIREVOLE



| art. | imballo | colore | euro |
|-------|---------|--------|-------|
| P5234 | 100 pz. | | 2,51* |

*prezzo per 100 pz.

MENSOLA A PARETE REGOLABILE

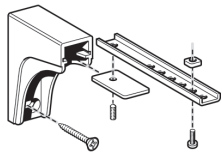

| art. | sporgenza | imballo | euro |
|-------|-----------|---------|------|
| P4142 | 10-15 cm | 10 pz. | 5,10 |
| P4142 | 16-20 cm | 10 pz. | 5,67 |
| P4142 | 21-25 cm | 10 pz. | 6,03 |

M2NET - TRASMETTITORE R. F.



| art. | imballo | | euro |
|-------|---------|-----------|--------|
| P5441 | 1 pz. | 1 sistema | 156,76 |
| P5444 | 1 pz. | 4 sistemi | 232,00 |

M2NET - TRASMETTITORE R. F. DA PARETE



| art. | imballo | | euro |
|-------|---------|-----------|--------|
| P5451 | 1 pz. | 1 sistema | 144,33 |
| P5454 | 1 pz. | 4 sistemi | 242,17 |

M2NET-TRASMETTITORE R.F. 100 CANALI



| art. | imballo | colore | euro |
|-------|---------|--------|--------|
| P5449 | 1 pz. | bianco | 463,40 |

M2NET - PULSANTE DIGITALE DA PARETE



| art. | imballo | | euro |
|-------|---------|-------------|------|
| P5461 | 1 pz. | 1-2 sistemi | |
| P5431 | 1 pz. | 1 sistema | |

M2NET - TRASMETTITORE R.F. ULTRASLIM DA PARETE



| art. | imballo | | euro |
|-------|---------|------------|------|
| P5421 | 1 pz. | 1- sistema | |

P477



Dimensione profilo
L 100 mm
A 15 mm

Scala 1:2

SISTEMA PER TENDE AD ARRICCIATURA CONTINUA AD ONDA CON AZIONAMENTO A STRAPPO E A CORDA

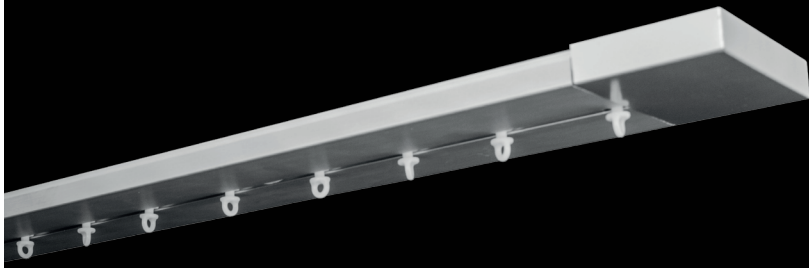

- Confezione standard con:
- art. P477/... - Profilo alluminio bianco
 - art. P4602 + P4601 - Carrucole
 - art. P4393 - Corda (Caduta 225 cm)
 - art. P4482 - Fissacordoni
 - art. P4552/1 - Distanziale 60 mm
 - art. P4552/2 - Distanziale 80 mm
 - art. P4483 - Chiavetta di fissaggio

Sistema indicato per tendaggi ad arricciatura continua ad onda con azionamento a strappo e a corda.

FISSAGGIO

art. P1362 Fissaggio a parete 147,8 mm

art. P1363 Fissaggio a parete 207,8 mm

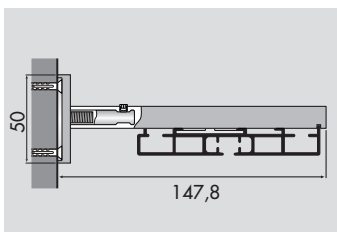

art. P4483 Fissaggio a soffitto

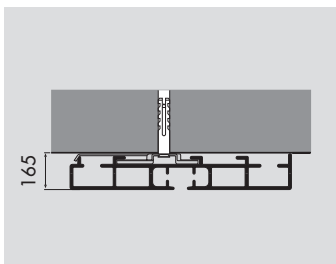

FISSAGGI OPZIONALI

art. P1397 Fissaggio a soffitto

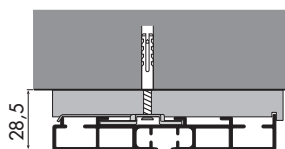

art. P1393 Fissaggio a soffitto

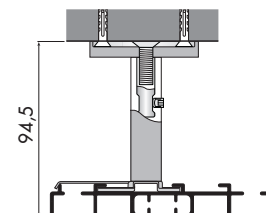

PREZZI

art. P477stM1 Catenella a strappo 60 mm

art. P477stM2 Catenella a strappo 80 mm

art. P477stM3 Scivoli 4263 a strappo

art. P477cM1 Catenella a corda 60 mm

art. P477cM2 Catenella a corda 80 mm

art. P477cM3 Scivoli 4263 a corda

| strappo L cm | P477stM 1 Al.Sat/B | P477stM 1 Al. INOX | P477stM 2 Al.Sat/B | P477stM 2 Al. INOX | P477stM 3 Al.Sat/B | P477stM 3 Al. INOX |
|-----------------|-----------------------|-----------------------|-----------------------|-----------------------|-----------------------|-----------------------|
| | Euro | Euro | Euro | Euro | Euro | Euro |
| 140 | 142,12 | 151,15 | 142,12 | 151,15 | 125,66 | 134,00 |
| 160 | 157,59 | 167,13 | 157,59 | 167,13 | 141,37 | 150,95 |
| 180 | 172,78 | 183,55 | 172,78 | 183,55 | 155,32 | 166,09 |
| 200 | 188,49 | 200,44 | 188,49 | 200,44 | 169,64 | 181,59 |
| 220 | 204,20 | 217,33 | 204,20 | 217,33 | 185,61 | 198,74 |
| 240 | 220,42 | 234,74 | 220,42 | 234,74 | 200,44 | 214,76 |
| 260 | 236,24 | 251,78 | 236,24 | 251,78 | 215,89 | 231,39 |
| 280 | 252,45 | 269,19 | 252,45 | 269,19 | 231,34 | 248,08 |
| 300 | 269,04 | 286,96 | 269,04 | 286,96 | 247,05 | 264,97 |
| 320 | 285,41 | 304,47 | 285,41 | 304,47 | 262,91 | 282,01 |
| 340 | 302,20 | 322,49 | 302,20 | 322,49 | 278,72 | 299,01 |
| 360 | 319,40 | 340,93 | 319,40 | 340,93 | 295,10 | 316,52 |
| 380 | 336,40 | 359,11 | 336,40 | 359,11 | 311,27 | 333,93 |
| 400 | 353,75 | 377,65 | 353,75 | 377,65 | 327,85 | 351,75 |
| 420 | 371,21 | 396,29 | 371,21 | 396,29 | 344,59 | 369,62 |
| 440 | 388,93 | 415,19 | 388,93 | 415,19 | 361,27 | 387,54 |
| 460 | 406,49 | 433,99 | 406,49 | 433,99 | 378,53 | 405,97 |
| 480 | 424,46 | 453,15 | 424,46 | 453,15 | 395,73 | 424,36 |
| 500 | 442,59 | 472,46 | 442,59 | 472,46 | 412,77 | 442,64 |
| 520 | 461,03 | 492,08 | 461,03 | 492,08 | 430,54 | 461,54 |
| 540 | 479,41 | 511,65 | 479,41 | 511,65 | 448,00 | 480,24 |
| 560 | 498,01 | 531,43 | 498,01 | 531,43 | 465,82 | 499,24 |
| 580 | 516,85 | 551,46 | 516,85 | 551,46 | 483,69 | 518,30 |
| 600 | 535,70 | 571,50 | 535,70 | 571,50 | 501,76 | 537,56 |

| corda L cm | P477cM 1 Al.Sat/B | P477cM 1 Al. INOX | P477cM 2 Al.Sat/B | P477cM 2 Al. INOX | P477cM 3 Al.Sat/B | P477cM 3 Al. INOX |
|---------------|----------------------|----------------------|----------------------|----------------------|----------------------|----------------------|
| | Euro | Euro | Euro | Euro | Euro | Euro |
| 140 | 167,53 | 175,87 | 167,53 | 175,87 | 159,44 | 167,84 |
| 160 | 185,61 | 195,19 | 185,61 | 195,19 | 176,44 | 185,98 |
| 180 | 201,83 | 212,54 | 201,83 | 212,54 | 191,37 | 202,14 |
| 200 | 218,26 | 230,21 | 218,26 | 230,21 | 206,98 | 218,93 |
| 220 | 236,90 | 250,03 | 236,90 | 250,03 | 224,17 | 237,31 |
| 240 | 253,84 | 268,16 | 253,84 | 268,16 | 240,14 | 254,46 |
| 260 | 270,89 | 286,44 | 270,89 | 286,44 | 255,85 | 271,41 |
| 280 | 288,30 | 304,98 | 288,30 | 304,98 | 271,71 | 288,40 |
| 300 | 307,35 | 325,27 | 307,35 | 325,27 | 289,53 | 307,46 |
| 320 | 324,86 | 343,92 | 324,86 | 343,92 | 306,12 | 325,22 |
| 340 | 342,78 | 363,08 | 342,78 | 363,08 | 322,44 | 342,73 |
| 360 | 362,56 | 384,04 | 362,56 | 384,04 | 340,93 | 362,41 |
| 380 | 380,74 | 403,45 | 380,74 | 403,45 | 357,77 | 380,43 |
| 400 | 398,87 | 422,71 | 398,87 | 422,71 | 374,87 | 398,71 |
| 420 | 417,30 | 442,39 | 417,30 | 442,39 | 391,81 | 416,89 |
| 440 | 436,05 | 462,32 | 436,05 | 462,32 | 409,27 | 435,54 |
| 460 | 454,90 | 482,35 | 454,90 | 482,35 | 426,63 | 454,08 |
| 480 | 474,01 | 502,64 | 474,01 | 502,64 | 444,34 | 472,98 |
| 500 | 494,86 | 524,68 | 494,86 | 524,68 | 463,96 | 493,78 |
| 520 | 514,07 | 545,13 | 514,07 | 545,13 | 481,94 | 512,94 |
| 540 | 533,69 | 565,93 | 533,69 | 565,93 | 499,04 | 531,22 |
| 560 | 553,26 | 586,69 | 553,26 | 586,69 | 518,35 | 551,77 |
| 580 | 573,25 | 607,91 | 573,25 | 607,91 | 536,58 | 571,19 |
| 600 | 593,13 | 628,92 | 593,13 | 628,92 | 555,32 | 591,12 |

ARRICCIATURA

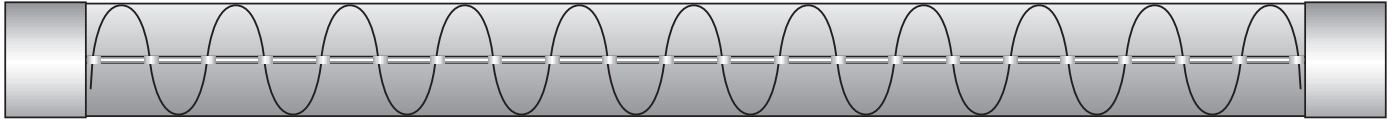

L'arricciatura continua della tenda è realizzata per mezzo di una corda distanziatrice all'interno del canale di scorrimento degli scivoli.

MISURE CONSIGLIATE

| APERTURA LATERALE | | | | | | APERTURA CENTRALE | | | | | |
|-------------------|--------|--------|---------|--------|--------|-------------------|--------|--------|---------|--------|--------|
| 60 mm | | | | | | 80 mm | | | | | |
| 477 ST1 | (*) pz | 477 C1 | 477 ST2 | (*) pz | 477 C2 | 477 ST1 | (*) pz | 477 C1 | 477 ST2 | (*) pz | 477 C2 |
| 54 | 8 | 46 | 65 | 8 | 58 | 47 | 8 | 30 | 59 | 8 | 47 |
| 66 | 10 | 58 | 81 | 10 | 74 | 71 | 12 | 59 | 91 | 12 | 67 |
| 78 | 12 | 70 | 97 | 12 | 90 | 94 | 16 | 83 | 123 | 16 | 101 |
| 90 | 14 | 82 | 113 | 14 | 106 | 118 | 20 | 105 | 154 | 20 | 143 |
| 102 | 16 | 94 | 129 | 16 | 122 | 142 | 24 | 129 | 186 | 24 | 175 |
| 113 | 18 | 105 | 144 | 18 | 137 | 165 | 28 | 153 | 218 | 28 | 206 |
| 125 | 20 | 117 | 160 | 20 | 153 | 189 | 32 | 176 | 249 | 32 | 238 |
| 137 | 22 | 129 | 177 | 22 | 169 | 213 | 36 | 200 | 282 | 36 | 270 |
| 148 | 24 | 141 | 193 | 24 | 185 | 236 | 40 | 224 | 313 | 40 | 301 |
| 161 | 26 | 153 | 209 | 26 | 201 | 259 | 44 | 247 | 345 | 44 | 333 |
| 172 | 28 | 164 | 225 | 28 | 216 | 283 | 48 | 269 | 377 | 48 | 364 |
| 184 | 30 | 176 | 241 | 30 | 232 | 307 | 52 | 294 | 409 | 52 | 396 |
| 196 | 32 | 188 | 257 | 32 | 248 | 330 | 56 | 317 | 441 | 56 | 429 |
| 208 | 34 | 200 | 273 | 34 | 264 | 354 | 60 | 341 | 473 | 60 | 460 |
| 220 | 36 | 212 | 289 | 36 | 280 | 377 | 64 | 365 | 505 | 64 | 492 |
| 231 | 38 | 223 | 304 | 38 | 295 | 401 | 68 | 380 | 537 | 68 | 523 |
| 243 | 40 | 235 | 320 | 40 | 311 | 425 | 72 | 412 | 569 | 72 | 555 |
| 255 | 42 | 247 | 336 | 42 | 327 | 449 | 76 | 436 | 601 | 76 | 587 |
| 267 | 44 | 259 | 352 | 44 | 343 | 472 | 80 | 460 | | | |
| 279 | 46 | 271 | 368 | 46 | 359 | 496 | 84 | 484 | | | |
| 290 | 48 | 283 | 383 | 48 | 374 | 519 | 88 | 507 | | | |
| 302 | 50 | 295 | 399 | 50 | 390 | 543 | 92 | 531 | | | |
| 314 | 52 | 306 | 415 | 52 | 406 | 567 | 96 | 555 | | | |
| 326 | 54 | 319 | 431 | 54 | 422 | 590 | 100 | 567 | | | |
| 338 | 56 | 331 | 447 | 56 | 438 | | | | | | |
| 349 | 58 | 342 | 462 | 58 | 453 | | | | | | |
| 361 | 60 | 353 | 478 | 60 | 469 | | | | | | |
| 373 | 62 | 365 | 494 | 62 | 485 | | | | | | |
| 386 | 64 | 377 | 510 | 64 | 501 | | | | | | |
| 398 | 66 | 389 | 526 | 66 | 517 | | | | | | |
| 408 | 68 | 400 | 541 | 68 | 533 | | | | | | |
| 421 | 70 | 412 | 557 | 70 | 549 | | | | | | |
| 433 | 72 | 424 | 573 | 72 | 565 | | | | | | |
| 445 | 74 | 437 | 589 | 74 | 581 | | | | | | |
| 457 | 76 | 449 | 606 | 76 | 597 | | | | | | |
| 468 | 78 | 460 | | | | | | | | | |
| 480 | 80 | 472 | | | | | | | | | |
| 492 | 82 | 484 | | | | | | | | | |
| 504 | 84 | 496 | | | | | | | | | |
| 516 | 86 | 508 | | | | | | | | | |
| 527 | 88 | 519 | | | | | | | | | |
| 539 | 90 | 531 | | | | | | | | | |
| 551 | 92 | 543 | | | | | | | | | |
| 563 | 94 | 555 | | | | | | | | | |
| 575 | 96 | 567 | | | | | | | | | |
| 586 | 98 | 578 | | | | | | | | | |
| 598 | 100 | 590 | | | | | | | | | |
| 610 | 102 | 604 | | | | | | | | | |

PROFILO ALLUMINIO 100x15mm

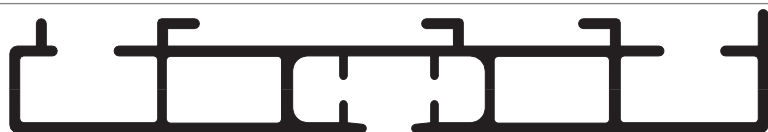

*lunghezza aste 6 m

| art. | imballo | colore | euro |
|------|---------|--------------------|-------|
| P477 | 30m | alluminio satinato | 46,98 |
| P477 | 30m | alluminio cromato | 56,14 |
| P477 | 30m | bianco | 46,98 |

CARRUCOLA DI CADUTA

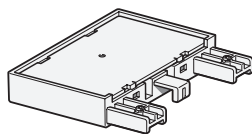

| art. | imballo | colore | euro |
|-------|---------|----------------|-------|
| P4602 | 1 pz. | bianco | 21,73 |
| P4602 | 1 pz. | cromato | 24,99 |
| P4602 | 1 pz. | alluminio inox | 21,73 |

SCIVOLO IN MATEROZZA



| art. | imballo | colore | euro |
|-------|----------|--------|-------|
| P4263 | 1000 pz. | | 8,09* |

*prezzo per 100 pz.

CARRUCOLA DI RINVIO

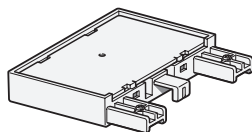

| art. | imballo | colore | euro |
|-------|---------|----------------|-------|
| P4601 | 1 pz. | bianco | 13,96 |
| P4601 | 1 pz. | cromato | 17,62 |
| P4601 | 1 pz. | alluminio inox | 13,96 |

SET ARRESTO MAGNETICO PER SISTEMI A STRAPPO

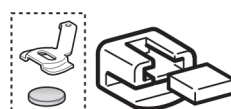

| art. | imballo | colore | euro |
|-------|---------|--------|------|
| P4603 | 10 pz. | | 6,91 |

CORDA 100% NYLON Ø 3 mm



| art. | imballo | colore | euro |
|-------|---------|--------|--------|
| P4393 | 500 m | bianco | 106,81 |

MENSOLA A SOFFITTO 8cm



| art. | imballo | colore | euro |
|-------|---------|--------------------|-------|
| P1393 | 1 pz. | alluminio satinato | 70,56 |
| P1393 | 1 pz. | cromato | 70,56 |
| P1393 | 1 pz. | bianco | 70,56 |

SORMONTO IN PLASTICA

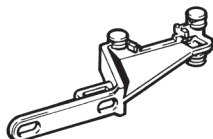

| art. | imballo | colore | euro |
|-------|---------|--------|------|
| P4185 | 100 pz. | | 2,94 |

MENSOLA A SOFFITTO



| art. | imballo | colore | euro |
|-------|---------|--------------------|-------|
| P1379 | 1 pz. | alluminio satinato | 48,20 |
| P1379 | 1 pz. | cromato | 48,20 |
| P1379 | 1 pz. | bianco | 48,20 |

ASTA DI SORMONTO

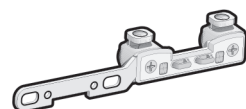

| art. | imballo | colore | euro |
|-------|---------|--------|------|
| P4087 | 20 pz. | | 7,14 |

MENSOLA A PARETE

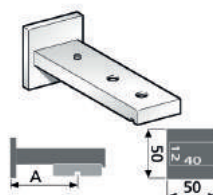

| art. | A | colore | euro |
|-------|--------|--------------------|-------|
| P1362 | 95 mm | alluminio satinato | 75,93 |
| P1362 | 95 mm | cromato | 75,93 |
| P1362 | 95 mm | bianco | 75,93 |
| P1363 | 155 mm | alluminio satinato | 82,16 |
| P1363 | 155 mm | cromato | 82,16 |
| P1363 | 155 mm | bianco | 82,16 |

CHIAVETTA GIREVOLE



| art. | imballo | colore | euro |
|-------|---------|--------|--------|
| P4483 | 100 pz. | | 112,20 |

*prezzo per 100 pz.

*imballo 1 pz.

ASTA DI SORMONTO PER SISTEMI A ONDA

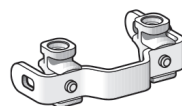

| art. | imballo | mm | euro |
|-------|---------|-------|-------|
| P4604 | 1 pz. | 60 mm | 21,00 |
| P4605 | 1 pz. | 80 mm | 21,27 |

NASTRO TRASPARENTE 75 mm

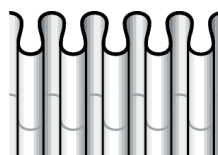

| art. | imballo | mm | euro |
|------|---------|-------|------|
| P799 | 50 m | 75 mm | 2,62 |

FISSACORDONE REGOLABILE

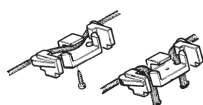

| art. | imballo | colore | euro |
|-------|---------|--------|------|
| P4482 | 50 pz. | | 3,81 |

FIOCCO UNIVERSALE 60g



| art. | imballo | colore | euro |
|-------|---------|--------|-----------|
| P1580 | 25 pz. | bianco | 2,38 cad. |

DISTANZIALE/SCIVOLO

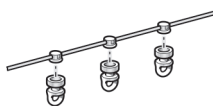

| art. | imballo | mm | euro |
|-------|---------|-------|-------|
| P4552 | 100 m. | 60 mm | 11,59 |
| P4552 | 100 m. | 80 mm | 10,86 |

P205

SISTEMA A DUE CANALI PER TENDE E SOPRATENDE
USO DOMESTICO ED ALBERGHIERO



Dimensione profilo
L 94 mm
A 10.2 mm

Scala 1:1

Confezione standard con:

- art. P205 - Profilo alluminio bianco
- art. P4515 - Carrucole
- art. P4393 - Corda (Caduta 225 cm)
- art. P4206 + P4518 - Fissacordoni
- art. P4263 - Scivoli



Il sistema è destinato a doppie tende con mantovana applicabile tramite Velcro® su un apposito profilo frontale.

FISSAGGI

Fissaggio a soffitto

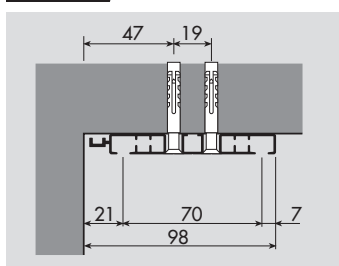

art. P4142 Fissaggio a parete

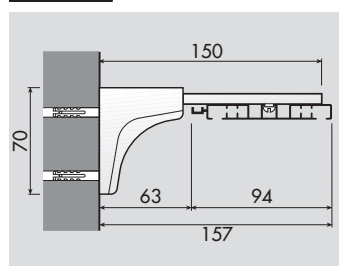

CURVE

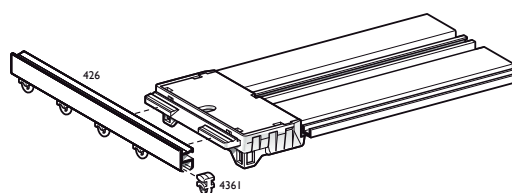

FISSAGGI OPZIONALI

Fissaggio a soffitto + P4447 - portamantovana

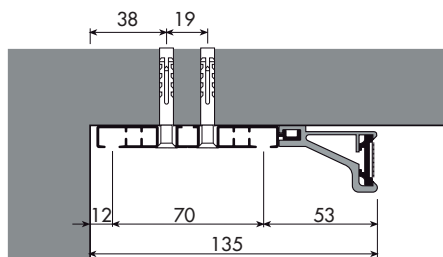

art. P4142 Fissaggio a parete + P4447 - portamantovana

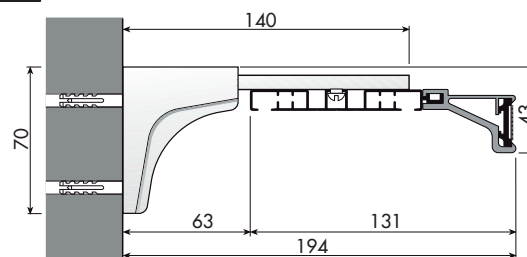

SCORREVOLI

art. P4263 Scivolo in materozza



art. P4144 Scorrevole a rulli



art. P4361 Scivolo per P426



SUPPLEMENTI A RICHIESTA

| | art. | desc. | colore | euro |
|------------------------------------|---------|-------|--------|-------|
| Scorrevole a rulli | P4144/C | al m | | 9,48 |
| Angoli con Nadir P426M | P4167/C | al m | | 38,11 |
| Con corde anche sul secondo canale | P205/2 | cad. | | 17,51 |

P205

| | | | | | | | | | | | | | | |
|---------------|--------|--------|--------|--------|--------|--------|--------|--------|--------|--------|--------|--------|--------|--------|
| LUNGHEZZA | 140 | 160 | 180 | 200 | 220 | 240 | 260 | 280 | 300 | 320 | 340 | 360 | 380 | 400 |
| PREZZO | 110,21 | 117,99 | 126,28 | 135,08 | 146,41 | 158,83 | 167,74 | 174,17 | 178,71 | 192,76 | 202,60 | 209,76 | 220,78 | 228,09 |
| CON MANTOVANA | 140,20 | 152,29 | 164,85 | 177,93 | 193,54 | 207,18 | 223,46 | 234,17 | 242,98 | 261,36 | 275,42 | 286,86 | 302,20 | 313,79 |

PROFILO ALLUMINIO 94x10,2 mm



| art. | imballo | colore | euro |
|------|---------|--------|-------|
| P205 | 30m | bianco | 37,40 |

*lunghezza aste 6 m

COPIA CARRUCOLE

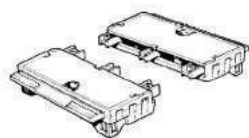

| art. | imballo | colore | euro |
|-------|---------|--------|-------|
| P4515 | 10 cp. | bianco | 17,75 |

SORMONTO IN PLASTICA

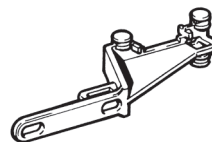

| art. | imballo | colore | euro |
|-------|---------|--------|------|
| P4185 | 100 pz. | | 2,94 |

TAPPO TERMINALE

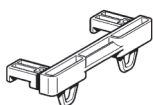

| art. | imballo | colore | euro |
|-------|---------|--------|------|
| P4517 | 50 pz. | bianco | 2,68 |

SORMONTO IN PLASTICA 7 cm

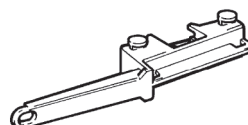

| art. | imballo | colore | euro |
|-------|---------|--------|------|
| P4585 | 50 pz. | | 3,35 |

FISSACORDONE REGOLABILE

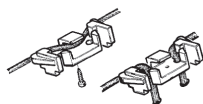

| art. | imballo | colore | euro |
|-------|---------|--------|------|
| P4482 | 50 pz. | | 3,81 |

PROFILO VELCRATO 6 x 24mm



| art. | imballo | colore | euro |
|------|---------|--------|-------|
| P520 | 60 m | bianco | 19,38 |

Lunghezza aste 6 m

FISSACORDA

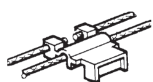

| art. | imballo | colore | euro |
|-------|---------|--------|------|
| P4518 | 50 pz. | | 3,87 |

SUPPORTO PORTAMANTOVANA



| art. | imballo | colore | euro |
|-------|---------|--------|-----------|
| P4447 | 50 pz. | | 1,80 cad. |

CORDA 100% NYLON Ø 3 mm



| art. | imballo | colore | euro |
|-------|---------|--------|--------|
| P4393 | 500 m | bianco | 106,81 |

SUPPORTO MANTOVANA FORATO

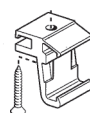

| art. | imballo | colore | euro |
|-------|---------|--------|-----------|
| P4448 | 50 pz. | | 1,80 cad. |

ARRESTO GIREVOLE



| art. | imballo | colore | euro |
|-------|---------|--------|------|
| P4277 | 100 pz. | | 1,00 |

TAPPO TERMINALE



| art. | imballo | colore | euro |
|-------|---------|--------|-----------|
| P4094 | 200 pz. | | 1,06 cad. |

SCIVOLO IN MATEROZZA



| art. | imballo | colore | euro |
|-------|----------|--------|-------|
| P4263 | 1000 pz. | | 8,09* |

*prezzo per 100 pz.

PROFILO ALLUMINIO 9 x 13 mm



| art. | imballo | colore | euro |
|------|---------|--------|-------|
| P426 | 60 m | bianco | 13,79 |

Lunghezza aste 6 m

SCORREVOLE A RULLI



| art. | imballo | colore | euro |
|-------|---------|--------|--------|
| P4144 | 500 pz. | | 51,27* |

*prezzo per 100 pz.

ARRESTO GIREVOLE PER P426



| art. | imballo | colore | euro |
|-------|---------|--------|------|
| P4365 | 100 pz. | | 1,01 |

*prezzo per 100 pz.

MENSOLA A PARETE REGOLABILE

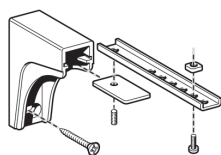

| art. | sporgenza | imballo | euro |
|-------|-----------|---------|------|
| P4142 | 10-15 cm | 10 pz. | 5,10 |
| P4142 | 16-20 cm | 10 pz. | 5,67 |
| P4142 | 21-25 cm | 10 pz. | 6,03 |

SCIVOLO IN MATEROZZA



| art. | imballo | colore | euro |
|-------|----------|--------|------------|
| PK145 | 1000 pz. | | 26,26 cad. |

*prezzo per 1000 pz.

TAPPO PER FORO DA \varnothing 9 mm



| art. | imballo | colore | euro |
|-------|---------|--------|-------|
| P4374 | 100 pz. | | 75,00 |

*prezzo per 100 pz.

TENDICORDA DI SICUREZZA



| art. | imballo | colore | euro |
|-------|---------|--------|------|
| P3636 | 50 pz. | bianco | 3,15 |

FIOCCO UNIVERSALE 60g



| art. | imballo | colore | euro |
|-------|---------|--------|-----------|
| P1580 | 25 pz. | bianco | 2,38 cad. |

P441

SISTEMA TENDE A PACCHETTO INSTALLAZIONE A SERRAMENTO



Dimensione profilo
L 6 mm
A 24 mm

Scala 1:1



Confezione standard con:

- art. P520 - Profilo alluminio veltrato
- art. P4094 - Tappi terminali
- art. P4099 - Arresto frontale
- art. P4103 - Supporto
- art. P4121 - Corda
- art. P4118 - Giunto
- art. P4124 - Peso tenda

Sistema per tende a pacchetto ultrapiatto ad uso domestico.
Particolarmente adatto per installazione su serramento.

FISSAGGIO

art. P4093 Fissaggio a soffitto

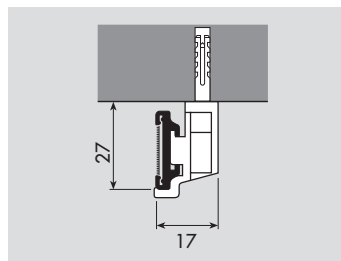

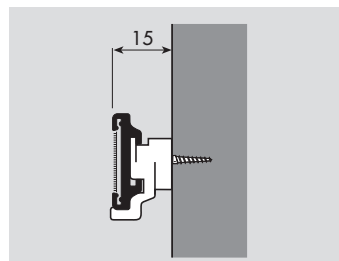

art. P4097 Fissaggio a parete

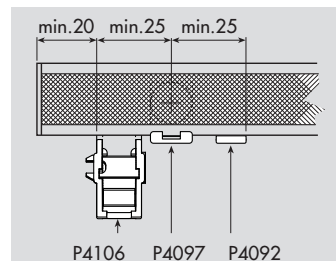

art. P441 montaggio accessori



INSTALLAZIONE

| L cm |   | |
|-----------|---|-------|
| | P4092 | P4097 |
| → 60 | 2 | 2 |
| 61 → 110 | 3 | 3 |
| 111 → 150 | 4 | 4 |

PORTATA

Indicato per tendaggi
L max 150 cm ed H 300 cm
di peso non superiore a 1,4 kg.

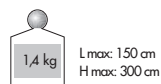

SUPPLEMENTI A RICHIESTA

| | art. | desc. | colore | euro |
|---------------------------------|-------|-------|--------|-------|
| Curve ad arco raggio 50 cm min. | - | al m | | 21,22 |
| Aste in fibra di vetro ø 4 mm | P4078 | al m | | 2,27 |

P441

| LUNGHEZZA | 50 | 60 | 70 | 80 | 90 | 100 | 110 | 120 | 130 | 140 | 150 |
|---------------|-------|-------|-------|-------|-------|-------|-------|-------|-------|-------|-------|
| PREZZO | 48,00 | 49,65 | 61,95 | 63,60 | 65,25 | 66,85 | 68,60 | 71,64 | 82,55 | 84,36 | 85,95 |
| NUMERO CADUTE | 2 | 2 | 3 | 3 | 3 | 3 | 3 | 4 | 4 | 4 | 4 |

PROFILO VELCRATO 6 x 24mm



| art. | imballo | colore | euro |
|------|---------|--------|-------|
| P520 | 60 m | bianco | 19,38 |

Lunghezza aste 6 m

ARRESTO FRONTALE



| art. | imballo | colore | euro |
|-------|---------|--------|------|
| P4099 | 50 pz. | | 9,85 |

SUPPORTO OCCHIOLO



| art. | imballo | colore | euro |
|-------|---------|--------|-----------|
| P4103 | 150 pz. | | 1,48 cad. |

OCCHIOLO



| art. | imballo | colore | euro |
|-------|---------|--------|------|
| P4092 | 100 pz. | | 1,41 |

SUPPORTO A SCATTO A SOFFITTO

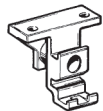

| art. | imballo | colore | euro |
|-------|---------|--------|------|
| P4093 | 100 pz. | | 1,41 |

SUPPORTO A SCATTO A PARETE



| art. | imballo | colore | euro |
|-------|---------|--------|------|
| P4097 | 100 pz. | | 1,48 |

CORDINA ø 1.2 mm



| art. | imballo | colore | euro |
|-------|---------|--------|-------|
| P4121 | 500 m | | 61,60 |

GIUNTA CORDINO



| art. | imballo | colore | euro |
|-------|---------|---------|-----------|
| P4118 | 100 pz. | 4 corde | 1,47 cad. |
| P4118 | 100 pz. | 8 corde | 2,83 cad. |

ANELLINO FONDOTENDA



| art. | imballo | colore | euro |
|-------|---------|--------|-----------|
| P4143 | 500 pz. | | 0,21 cad. |

PIATTINA PESO TENDA



| art. | imballo | mm | euro |
|-------|---------|--------|------|
| P4124 | 60 m. | 4 x 30 | 7,54 |
| P4125 | 60 m. | 4 x 40 | 8,81 |

*lunghezza aste 6m

TAPPO TERMINALE

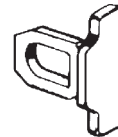

| art. | imballo | colore | euro |
|-------|---------|--------|-----------|
| P4094 | 200 pz. | | 1,06 cad. |

TONDINO



| art. | imballo | o | euro |
|------|---------|------------|------|
| TT6 | 120 m | 6 mm AL | 4,02 |
| TT8 | 120 m | 8 mm AL | 3,81 |
| 4078 | 60 m | 4 mm Fibra | 1,85 |

P419

SISTEMA TENDE A PACCHETTO - INSTALLAZIONE A SERRAMENTO



Dimensione profilo
L 6 mm
A 24 mm

Scala 1:1



Confezione standard con:

- art. P419 - Profilo alluminio veltrato
- art. P4357 - Tappi terminali
- art. P4556 - Arresto frontale
- art. P4558 - Occhioli
- art. P4081 - Supporto
- art. P4121 - Corda
- art. P4118 - Giunto
- art. P4124 - Peso tenda
- art. P4143 - Anellino fondo tenda

Sistema per tende a pacchetto lavaggio rapido.
Uso domestico. Azionamento a corda.

FISSAGGIO

art. P4112 Fissaggio a parete

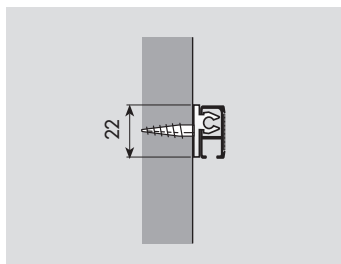

art. P4081 Fissaggio a soffitto

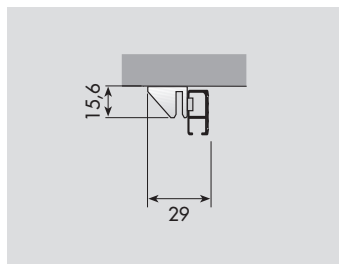

FISSAGGI OPZIONALI

art. P4083 Fissaggio a parete

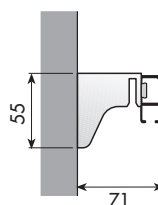

art. P4084 Fissaggio a parete

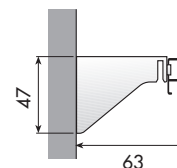

FISSAGGI OPZIONALI

art. P4085 Fissaggio a parete

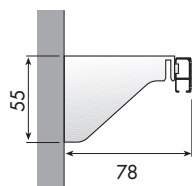

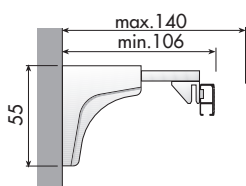

art. P4085 Fissaggio a parete

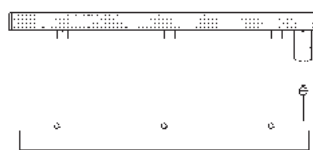

INSTALLAZIONE



| L cm |  P4558 |  P4112 |
|-----------|---|---|
| → 60 | 2 | 2 |
| 61 → 110 | 3 | 3 |
| 111 → 165 | 4 | 4 |

PORTATA

Indicato per tendaggi
L max 165 cm ed H 350 cm
di peso non superiore a 1,7 kg.

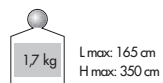

SUPPLEMENTI A RICHIESTA

| | art. | desc. | colore | euro |
|------------------------------------|-------|-------|--------|-------|
| Curve ad arco raggio 50 cm min. | - | al m | | 21,22 |
| Supporto a soffitto | P4081 | cad. | | - |
| Supporto parete 3 cm | P4083 | cad. | | 0,93 |
| Aste in fibra di vetro ø 4 mm | P4078 | al m | | 2,27 |
| Supporto universale per serramento | p4089 | cad. | | 11,07 |

P419

| | | | | | | | | | | | | |
|---------------|-------|-------|-------|-------|-------|-------|-------|-------|--------|--------|--------|--------|
| LUNGHEZZA | 50 | 60 | 70 | 80 | 90 | 100 | 110 | 120 | 130 | 140 | 150 | 165 |
| PREZZO | 58,04 | 62,83 | 68,13 | 73,13 | 77,92 | 83,43 | 88,99 | 94,66 | 100,94 | 106,81 | 113,25 | 124,53 |
| NUMERO CADUTE | 2 | 2 | 3 | 3 | 3 | 3 | 3 | 4 | 4 | 4 | 4 | 4 |

PROFILO ALLUMINIO 22,6X10,7 mm

| art. | imballo | colore | euro |
|------|---------|--------|-------|
| P419 | 60 m | bianco | 20,16 |



*lunghezza aste 6 m

ARRESTO FRONTALE

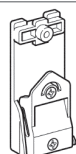

| art. | imballo | colore | euro |
|-------|---------|--------|-----------|
| P4556 | 50 pz. | | 5,56 cad. |

OCCHIOLO PASSACORDA

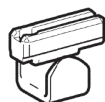

| art. | imballo | colore | euro |
|-------|---------|--------|------|
| P4558 | 100 pz. | | 1,41 |

*prezzo per 100 pz.

SUPPORTO PER SERRAMENTO



| art. | imballo | colore | euro |
|-------|---------|--------|------|
| P4112 | 100 pz. | | 1,92 |

*prezzo per 100 pz.

SUPPORTO A SOFFITTO

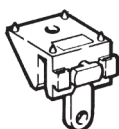

| art. | imballo | colore | euro |
|-------|---------|--------|------|
| P4081 | 100 pz. | | 2,21 |

SUPPORTO A PARETE 3 cm

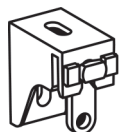

| art. | imballo | colore | euro |
|-------|---------|--------|------|
| P4083 | 100 pz. | | 2,78 |

SUPPORTO A PARETE 5,5 cm

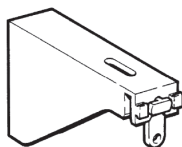

| art. | imballo | colore | euro |
|-------|---------|--------|------|
| P4084 | 50 pz. | | 3,97 |

SUPPORTO A PARETE 7,0 cm

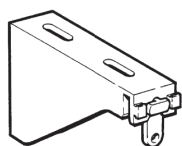

| art. | imballo | colore | euro |
|-------|---------|--------|------|
| P4085 | 50 pz. | | 4,22 |

SUPPORTO A PRESSIONE PER SERRAMENTI



| art. | imballo | colore | euro |
|-------|---------|------------------|-------|
| P4089 | 10 pz. | argento - grigio | 11,07 |
| P4089 | 10 pz. | bianco | 11,07 |

CORDINA ø 1,2 mm



| art. | imballo | colore | euro |
|-------|---------|--------|-------|
| P4121 | 500 m | | 61,60 |

ANELLINO FONDOTENDA



| art. | imballo | colore | euro |
|-------|---------|--------|-----------|
| P4143 | 500 pz. | | 0,21 cad. |

TAPPO TERMINALE

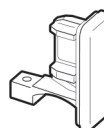

| art. | imballo | colore | euro |
|-------|---------|--------|-----------|
| P4357 | 50 pz. | bianco | 1,81 cad. |

GIUNTA CORDINO



| art. | imballo | colore | euro |
|-------|---------|---------|-----------|
| P4118 | 100 pz. | 4 corde | 1,47 cad. |
| P4118 | 100 pz. | 8 corde | 2,83 cad. |

PIATTINA PESO TENDA



| art. | imballo | mm | euro |
|-------|---------|--------|------|
| P4124 | 60 m. | 4 x 30 | 7,54 |
| P4125 | 60 m. | 4 x 40 | 8,81 |

*lunghezza aste 6m

P439

SISTEMA PER TENDE A PACCHETTO ULTRAPIATTO AZIONAMENTO A CATENELLA - INSTALLAZIONE A SERRAMENTO - LAVAGGIO RAPIDO



Dimensione profilo
L 6 mm
A 24 mm

Scala 1:1



Confezione standard con:

- art. P520 - Profilo bianco
- art. P439 - Profilo alluminio guida
- art. P4094 - Tappi terminali
- art. P3274 - Anello catena (Caduta 160-215 cm)
- art. P4422 - P4424M - Coppia carrucole
- art. P4432 - Rocchetti
- art. P4429 - Supporto per nastro
- art. P1931 - Nastro 5 mm
- art. P4372 - Supporti a parete
- art. P4102 - Aggancio nastro
- art. P4124 - Pesotenda 4x30 mm

Sistema per tende a pacchetto leggere. Azionamento a catenella. Lavaggio rapido. L'installazione, preferibilmente su serramento o direttamente a soffitto, è con supporti a scatto che facilitano la rimozione del profilo.

FISSAGGIO

art. P4372 Fissaggio a parete

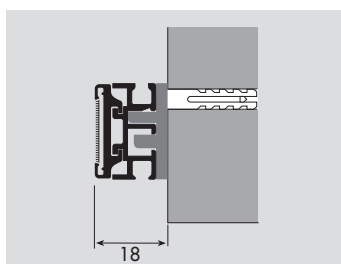

art. P4426 Fissaggio a soffitto

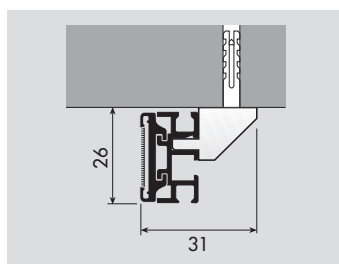

INSTALLAZIONE

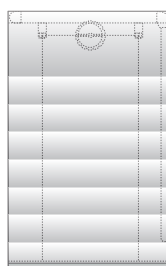

| L cm | | | |
|-----------|-------|-------|-------|
| | P4429 | P4372 | P4432 |
| → 60 | 2 | 2 | 1 |
| 61 → 110 | 3 | 3 | 2 |
| 111 → 140 | 4 | 4 | 2 |

UTILIZZO

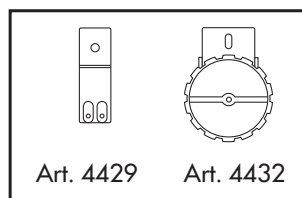
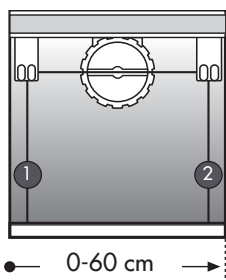

PORTATA

Indicato per tendaggi
L max 150 cm ed H 250 cm
di peso non superiore a 1,5 kg

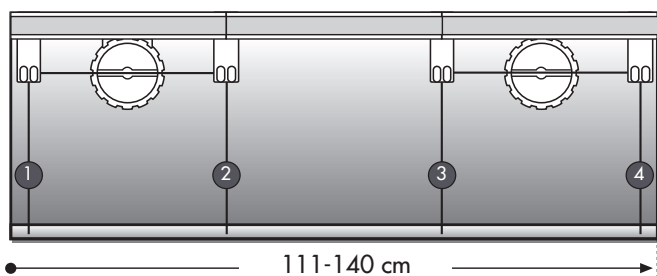
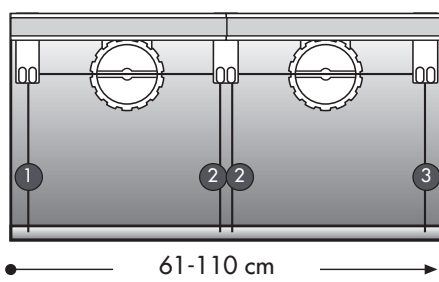
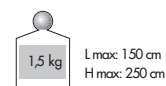
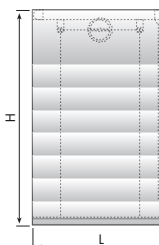

ALLINEAMENTO ROCCHETTI

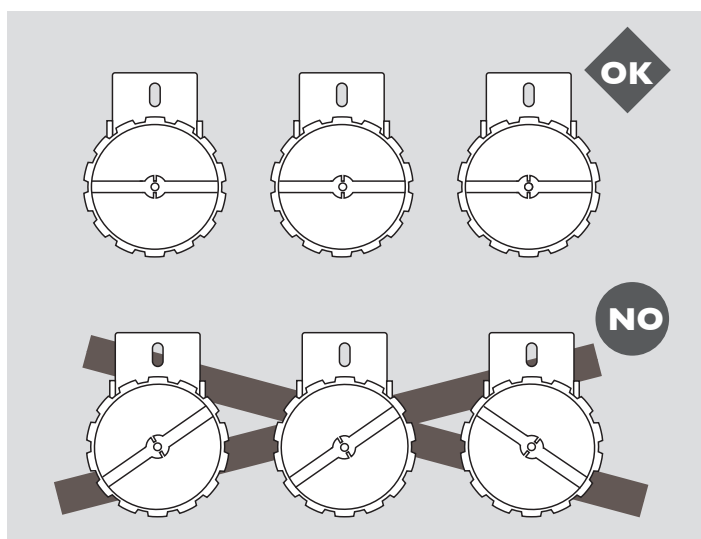

SUPPLEMENTI A RICHIESTA

| | art. | desc. | colore | euro |
|--|---------|-------|--------|-------|
| Caduta catenella precisa (tolleranza 5 cm) | P3274/C | al m | | 47,48 |
| Cordina ø 1 mm (in alternativa al nastro) | P4121/C | cad. | | - |
| Per ogni rocchetto supplementare | P4432 | | | 4,89 |
| Aste in fibra di vetro ø 4 mm | P4078/C | al m | | 2,27 |

P439

| LUNGHEZZA | 50 | 60 | 70 | 80 | 90 | 100 | 110 | 120 | 130 | 140 |
|------------------|-------|-------|-------|-------|-------|-------|--------|--------|--------|--------|
| PREZZO | 70,64 | 75,40 | 79,30 | 89,45 | 93,90 | 97,85 | 110,15 | 115,55 | 113,20 | 124,60 |
| NUMERO CADUTE | 2 | 2 | 3 | 3 | 3 | 3 | 3 | 4 | 4 | 4 |
| NUMERO ROCCHETTI | 1 | 1 | 2 | 2 | 2 | 2 | 2 | 2 | 2 | 2 |

PROFILO VELCRATO 6 x 24mm



| art. | imballo | colore | euro |
|------|---------|--------|-------|
| P520 | 60 m | bianco | 19,38 |

Lunghezza aste 6 m

PROFILO GUIDA 11 x 25 mm



| art. | imballo | colore | euro |
|------|---------|--------|-------|
| P439 | 45 m | bianco | 12,00 |

*lunghezza aste 4,5 m

COPIA CARRUCOLE (destra)

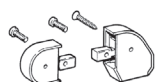

| art. | imballo | colore | euro |
|-------|---------|--------|------|
| P4422 | 20 cp. | | 4,43 |

COPIA CARRUCOLE (sinistra)

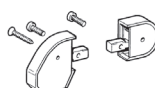

| art. | imballo | colore | euro |
|-------|---------|--------|------|
| P4424 | 20 cp. | | 4,43 |

ROCCHETTO

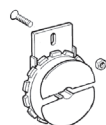

| art. | imballo | colore | euro |
|-------|---------|--------|------|
| P4432 | 50 pz. | | 4,89 |

SUPPORTO PER NASTRO

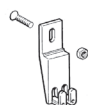

| art. | imballo | colore | euro |
|-------|---------|--------|------|
| P4429 | 100 pz. | | 2,29 |

CORDINA ø 1,2 mm



| art. | imballo | colore | euro |
|-------|---------|--------|-------|
| P4121 | 500 m | | 61,60 |

SUPPORTO A PARETE



| art. | imballo | colore | euro |
|-------|---------|--------|------|
| P4372 | 50 pz. | | 1,51 |

*prezzo per 100 pz.

SUPPORTO A SOFFITTO



| art. | imballo | colore | euro |
|-------|---------|--------|------|
| P4426 | 50 pz. | | 1,33 |

*prezzo per 100 pz.

ANELLO CATENA CONTINUO



| art. | imballo | cm | euro |
|----------|---------|-----|-------|
| P3274/20 | 15 pz. | 200 | 12,79 |
| P3274/25 | 15 pz. | 250 | 13,80 |
| P3274/30 | 15 pz. | 300 | 14,63 |
| P3274/35 | 15 pz. | 350 | 15,74 |
| P3274/40 | 15 pz. | 400 | 16,87 |
| P3274/45 | 15 pz. | 450 | 19,93 |
| P3274/50 | 15 pz. | 500 | 21,92 |
| P3274/55 | 15 pz. | 550 | 24,00 |
| P3274/60 | 15 pz. | 600 | 26,14 |
| P3274/65 | 15 pz. | 700 | 29,53 |

TENDICORDA DI SICUREZZA



| art. | imballo | colore | euro |
|-------|---------|--------|------|
| P3636 | 50 pz. | bianco | 3,15 |

TAPPO TERMINALE



| art. | imballo | colore | euro |
|-------|---------|--------|-----------|
| P4094 | 200 pz. | | 1,06 cad. |

PIATTINA PESO TENDA



| art. | imballo | mm | euro |
|-------|---------|--------|------|
| P4124 | 60 m. | 4 x 30 | 7,54 |
| P4125 | 60 m. | 4 x 40 | 8,81 |

*lunghezza aste 6m

NASTRO 5 mm

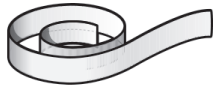

| art. | imballo | colore | euro |
|-------|---------|--------|------|
| P1931 | 150 m | bianco | 0,50 |
| P1931 | 150 m | trasp. | 0,63 |

*prezzo al m

ANELLINO FONDOTENDA



| art. | imballo | colore | euro |
|-------|---------|--------|-----------|
| P4143 | 500 pz. | | 0,21 cad. |

AGGANCIANO NASTRO REGOLABILE



| art. | imballo | colore | euro |
|-------|---------|--------|------|
| P4102 | 500 pz. | | 0,43 |

ANELLINO DA CUCIRE ø 9mm



| art. | imballo | colore | euro |
|-------|----------|--------|-------|
| P4168 | 1000 pz. | bianco | 30,18 |
| P4168 | 1000 pz. | trasp. | 25,13 |

*prezzo per 100 pz.

P414

SISTEMA PER TENDE A PACCHETTO INSTALLAZIONE UNIVERSALE - AZIONAMENTO A CORDA



Dimensione profilo
L 14 mm
A 23 mm

Scala 1:1

Confezione standard con:

- art. P414 - Profilo alluminio veltrato
- art. P4126 - Tappi terminali
- art. P4117 - Arresto frontale
- art. P4127 - Occhioli
- art. P4081 - Supporto
- art. P4128 - Corda
- art. P4118 - Giunto
- art. P4124 - Peso tenda
- art. P4143 - Anellino fondo tenda



Installazione a soffitto, a parete o direttamente su serramento.

FISSAGGIO

FISSAGGI OPZIONALI

art. P4081 Fissaggio a soffitto

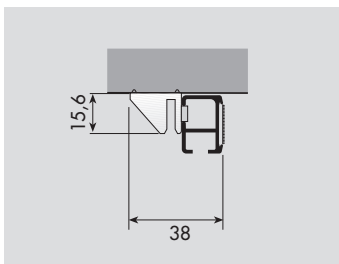

art. P4083 Fissaggio a parete

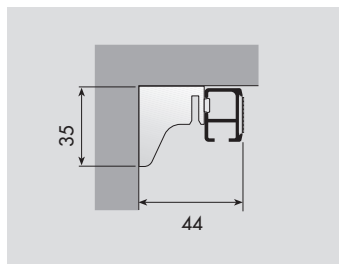

art. P4084 Fissaggio a parete

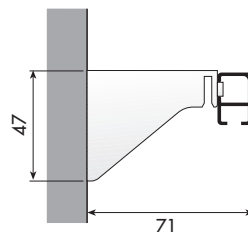

art. P4085 Fissaggio a parete

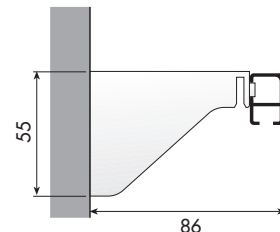

FISSAGGI OPZIONALI

PORTATA

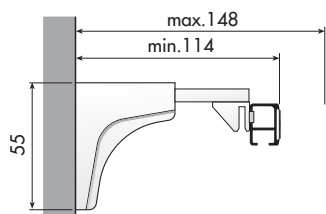

INSTALLAZIONE

art. P4142 Fissaggio a parete

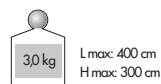
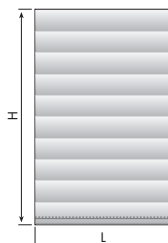

Indicato per tendaggi
L max 400 cm ed H 300 cm
di peso non superiore a 3.0 kg.



| L cm |   | |
|-----------|---|-------|
| | P4127 | P4081 |
| + 60 | 2 | 2 |
| 61 → 110 | 3 | 2 |
| 111 → 165 | 4 | 3 |
| 166 → 215 | 5 | 3 |
| 216 → 265 | 6 | 3 |
| 266 → 315 | 7 | 4 |
| 316 → 340 | 7 | 5 |
| 341 → 365 | 8 | 5 |
| 366 → 400 | 9 | 5 |

SUPPLEMENTI A RICHIESTA

| | art. | desc. | colore | euro |
|-------------------------------|---------|-------|--------|------|
| Supporti a parete 5,5 cm | P4084/C | cad. | | 2,78 |
| Supporti a parete 7 cm | P4085/C | cad. | | 3,22 |
| Aste in fibra di vetro ø 4 mm | P4078/C | al m | | 2,27 |
| Aste in alluminio ø 6 mm | P1854/C | al m | | 3,81 |

P414

| LUNGHEZZA | 60 | 70 | 110 | 136 | 165 | 190 | 215 | 240* | 265* | 315* | 340* | 365* | 400* |
|---------------|-------|-------|-------|--------|--------|--------|--------|--------|--------|--------|--------|--------|--------|
| PREZZO | 58,30 | 70,06 | 83,33 | 101,56 | 118,24 | 116,75 | 151,56 | 168,26 | 191,35 | 221,55 | 237,36 | 260,49 | 274,70 |
| NUMERO CADUTE | 2 | 3 | 3 | 4 | 4 | 5 | 5 | 6 | 6 | 7 | 7 | 8 | 9 |

* con 2 arresti P4117

PROFILO ALLUMINIO 14X23 mm

| art. | imballo | colore | euro |
|------|---------|--------|-------|
| P414 | 72 m | bianco | 23.17 |

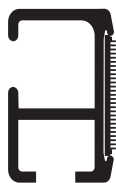

*lunghezza aste 6 m

ARRESTO FRONTALE



| art. | imballo | colore | euro |
|-------|---------|--------|------|
| P4117 | 20 pz. | | 7.07 |

OCCHIOLO PASSACORDA



| art. | imballo | colore | euro |
|-------|---------|--------|------|
| P4127 | 50 pz. | | 2.54 |

SUPPORTO A SOFFITTO

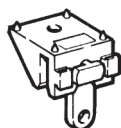

| art. | imballo | colore | euro |
|-------|---------|--------|------|
| P4081 | 100 pz. | | 2.21 |

SUPPORTO A PARETE 3 cm

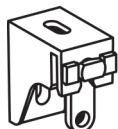

| art. | imballo | colore | euro |
|-------|---------|--------|------|
| P4083 | 100 pz. | | 2.78 |

SUPPORTO A PARETE 5,5 cm

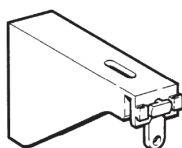

| art. | imballo | colore | euro |
|-------|---------|--------|------|
| P4084 | 50 pz. | | 3.97 |

SUPPORTO A PARETE 7,0 cm

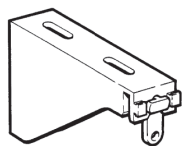

| art. | imballo | colore | euro |
|-------|---------|--------|------|
| P4085 | 50 pz. | | 4.22 |

MENSOLA A PARETE REGOLABILE

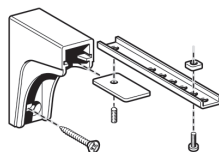

| art. | sporgenza | imballo | euro |
|-------|-----------|---------|------|
| P4142 | 10-15 cm | 10 pz. | 5.10 |
| P4142 | 16-20 cm | 10 pz. | 5.67 |
| P4142 | 21-25 cm | 10 pz. | 6.03 |

ARRESTO BASCULANTE

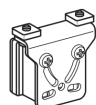

| art. | imballo | colore | euro |
|-------|---------|--------|-------|
| P4116 | 15 pz. | | 11.59 |

TAPPO TERMINALE



| art. | imballo | colore | euro |
|-------|---------|--------|-----------|
| P4126 | 100 pz. | | 1.16 cad. |

CORDINA ø 1,5 mm



| art. | imballo | colore | euro |
|-------|---------|--------|-------|
| P4128 | 500 m. | | 60.36 |

GIUNTA CORDINO



| art. | imballo | colore | euro |
|-------|---------|---------|-----------|
| P4118 | 100 pz. | 4 corde | 1.47 cad. |
| P4118 | 100 pz. | 8 corde | 2.83 cad. |

ANELLINO FONDOTENDA



| art. | imballo | colore | euro |
|-------|---------|--------|-----------|
| P4143 | 500 pz. | | 0.21 cad. |

ANELLINO DA CUCIRE ø 9mm



| art. | imballo | colore | euro |
|-------|----------|--------|-------|
| P4168 | 1000 pz. | bianco | 30.18 |
| P4168 | 1000 pz. | trasp. | 25.13 |

*prezzo per 100 pz.

PIATTINA PESO TENDA



| art. | imballo | mm | euro |
|-------|---------|--------|------|
| P4124 | 60 m. | 4 x 30 | 7.54 |
| P4125 | 60 m. | 4 x 40 | 8.81 |

*lunghezza aste 6m

TONDINO



| art. | imballo | ø | euro |
|------|---------|-----------------|------|
| TT6 | 120 m | 6 mm AL | 4.02 |
| TT8 | 120 m | 8 mm AL | 3.81 |
| 4078 | 60 m | 4 mm Fibra 1.85 | |

P427

SISTEMA PER TENDE A PACCHETTO PESANTI, INCLINATE E/O STECCATE

Installazione a soffitto, a parete o direttamente su serramento.



Dimensione profilo
L 14 mm
A 23 mm

Scala 1:1

Confezione standard con:

- art. P414 - Profilo bianco
- art. P4126 - Tappi terminali
- art. P4117 - Arresto frontale
- art. P4088 - Occhioli
- art. P4081 - Supporto
- art. P4128 - Corda
- art. P4118 - Giunto
- art. P4124 - Peso tenda

FISSAGGIO

art. P4081 Fissaggio a soffitto

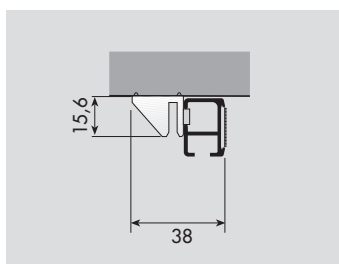

art. P4083 Fissaggio a parete

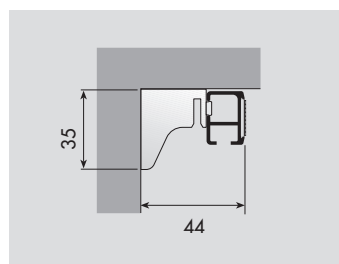

FISSAGGI OPZIONALI

art. P4084 Fissaggio a parete

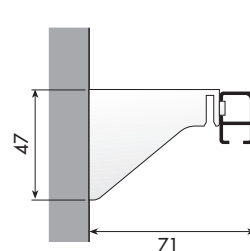

art. P4085 Fissaggio a parete

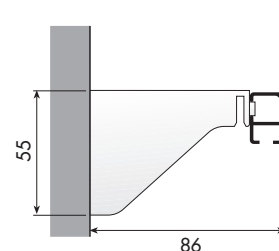

FISSAGGI OPZIONALI

art. P4142 Fissaggio a parete

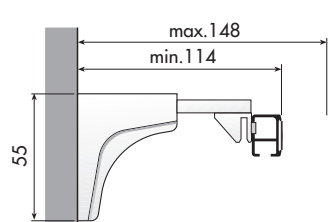

PORTATA

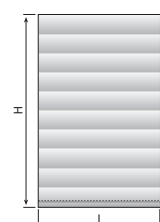



3,5 kg
Lmax: 500 cm
Hmax: 300 cm

CURVE

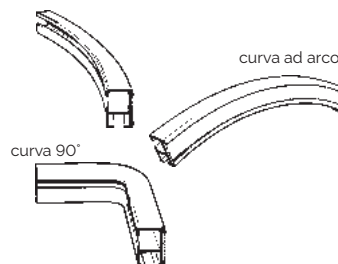
curva ad ampio raggio



INSTALLAZIONE

| L cm |   | |
|-----------|---|-------|
| | P4127 | P4081 |
| + 165 | 4 | 3 |
| 166 → 215 | 5 | 3 |
| 216 → 265 | 6 | 4 |
| 266 → 315 | 7 | 4 |
| 316 → 340 | 7 | 5 |
| 341 → 365 | 8 | 5 |
| 366 → 400 | 9 | 5 |
| 401 → 445 | 10 | 6 |
| 446 → 500 | 11 | 6 |

SUPPLEMENTI A RICHIESTA

| | art. | desc. | colore | euro |
|--|---------|-------|--------|-------|
| Supporti a parete 5,5 cm | P4084/C | cad. | | 2,78 |
| Supporti a parete 7 cm | P4085/C | cad. | | 3,22 |
| Sistema inclinato (con art. P4116) | P4116/C | cad. | | 4,53 |
| Curve ad arco raggio 50 cm min. (con art. P4116) | - | al m | | 21,19 |
| Curva a 90° - raggio 12 cm; agg. allo sviluppo totale per ogni curva (imb. al costo) | - | cad. | | 22,88 |
| Curve ad ampio raggio | - | al m | | 21,19 |
| Aste in fibra di vetro ø 4 mm | P4078/C | al m | | 2,27 |
| Aste in alluminio ø 6 mm | P1854/C | al m | | 3,81 |

P427

| LUNGHEZZA | 135 | 165 | 190 | 215 | 240 | 265 | 315* | 340* | 365* | 400* | 445* | 500* |
|---------------|--------|--------|--------|--------|--------|--------|--------|--------|--------|--------|--------|--------|
| PREZZO | 107,70 | 125,79 | 149,41 | 161,61 | 183,46 | 203,84 | 226,06 | 241,65 | 268,54 | 292,93 | 317,19 | 367,56 |
| NUMERO CADUTE | 4 | 4 | 5 | 5 | 6 | 6 | 7 | 7 | 8 | 9 | 10 | 11 |

* con 2 art. P4117

PROFILO ALLUMINIO 14X23 mm

| art. | imballo | colore | euro |
|------|---------|--------|-------|
| P414 | 72 m | bianco | 23,17 |

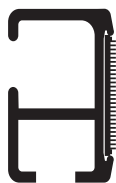

*lunghezza aste 6 m

ARRESTO FRONTALE

| art. | imballo | colore | euro |
|-------|---------|--------|------|
| P4117 | 20 pz. | | 7,07 |



OCCHIOLO A RULLI

| art. | imballo | colore | euro |
|-------|---------|--------|------|
| P4088 | 50 pz. | | 5,30 |



SUPPORTO A SOFFITTO

| art. | imballo | colore | euro |
|-------|---------|--------|------|
| P4081 | 100 pz. | | 2,21 |

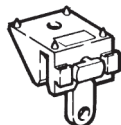

SUPPORTO A PARETE 3 cm

| art. | imballo | colore | euro |
|-------|---------|--------|------|
| P4083 | 100 pz. | | 2,78 |

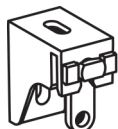

SUPPORTO A PARETE 5,5 cm

| art. | imballo | colore | euro |
|-------|---------|--------|------|
| P4084 | 50 pz. | | 3,97 |

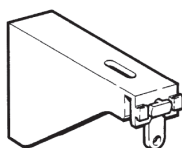

SUPPORTO A PARETE 7,0 cm

| art. | imballo | colore | euro |
|-------|---------|--------|------|
| P4085 | 50 pz. | | 4,22 |

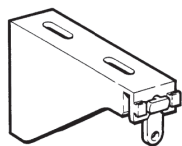

MENSOLA A PARETE REGOLABILE

| art. | sporgenza | imballo | euro |
|-------|-----------|---------|------|
| P4142 | 10-15 cm | 10 pz. | 5,10 |
| P4142 | 16-20 cm | 10 pz. | 5,67 |
| P4142 | 21-25 cm | 10 pz. | 6,03 |

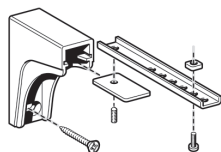

ARRESTO BASCULANTE

| art. | imballo | colore | euro |
|-------|---------|--------|-------|
| P4116 | 15 pz. | | 11,59 |

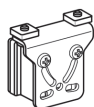

TAPPO TERMINALE

| art. | imballo | colore | euro |
|-------|---------|--------|-----------|
| P4126 | 100 pz. | | 1,16 cad. |



CORDINA ø 1,5 mm

| art. | imballo | colore | euro |
|-------|---------|--------|-------|
| P4128 | 500 m. | | 60,36 |



GIUNTA CORDINO

| art. | imballo | colore | euro |
|-------|---------|---------|-----------|
| P4118 | 100 pz. | 4 corde | 1,47 cad. |
| P4118 | 100 pz. | 8 corde | 2,83 cad. |



ANELLINO FONDOTENDA

| art. | imballo | colore | euro |
|-------|---------|--------|-----------|
| P4143 | 500 pz. | | 0,21 cad. |



ANELLINO DA CUCIRE ø 9mm

| art. | imballo | colore | euro |
|-------|----------|--------|-------|
| P4168 | 1000 pz. | bianco | 30,18 |
| P4168 | 1000 pz. | trasp. | 25,13 |



*prezzo per 100 pz.

PIATTINA PESO TENDA

| art. | imballo | mm | euro |
|-------|---------|--------|------|
| P4124 | 60 m. | 4 x 30 | 7,54 |
| P4125 | 60 m. | 4 x 40 | 8,81 |



*lunghezza aste 6m

TONDINO

| art. | imballo | ø | euro |
|------|---------|-----------------|------|
| TT6 | 120 m | 6 mm AL | 4,02 |
| TT8 | 120 m | 8 mm AL | 3,81 |
| 4078 | 60 m | 4 mm Fibra 1.85 | |



P444

SISTEMA CURVABILE PER TENDE A PACCHETTO
CON AZIONAMENTO A CATENELLA

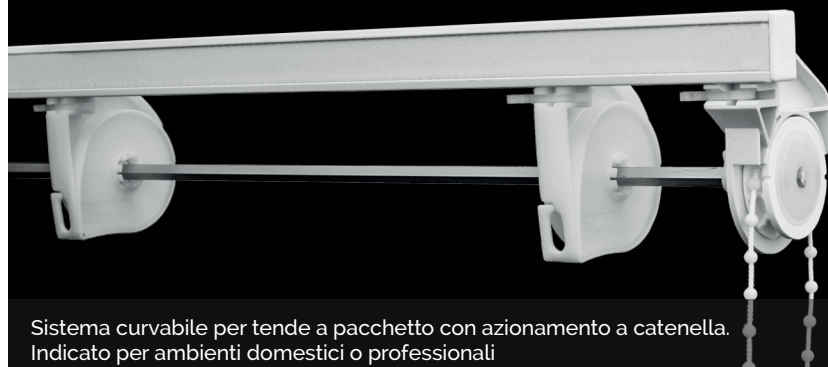

Sistema curvabile per tende a pacchetto con azionamento a catenella.
Indicato per ambienti domestici o professionali



Dimensione profilo
L 14 mm
A 23 mm

Scala 1:1

Confezione standard con:

- art. P414 - Profilo alluminio veltrato
- art. P3281 - Alberino di comando 5 mm
- art. P4126 - Tappi terminali
- art. P3624 - Anello catena (Caduta 160-215 cm)
- art. P3257-P4520-P3298 - Frizione
- art. P3295 - Rocchetti
- art. P1931 - Nastro 5 mm / cordino ϕ 1,2 mm
- art. P4081 - Supporti a soffitto
- art. P4102 - Aggancio nastro
- art. P4124 - Pesotenda 4x30 mm

FISSAGGIO

art. P4081 Fissaggio a soffitto

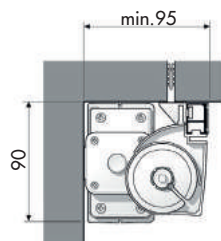

art. P4084 Fissaggio a parete

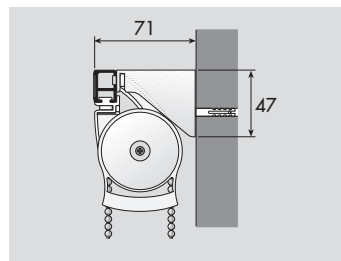

FISSAGGI OPZIONALI

art. P4085 Fissaggio a parete

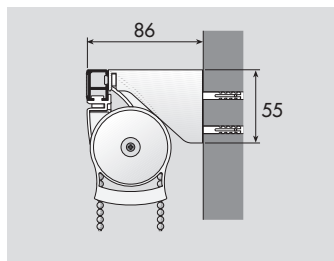

art. P4142 Fissaggio a parete

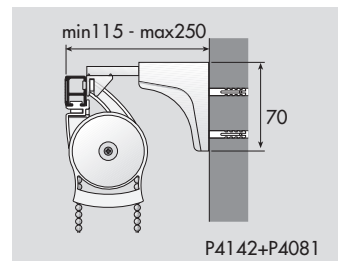

PORTATA

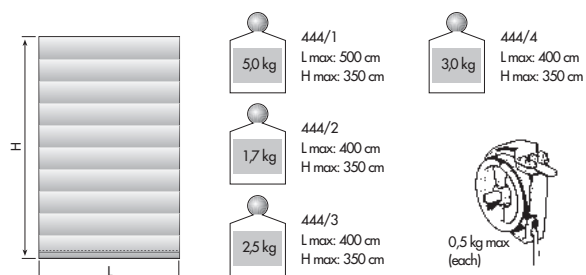

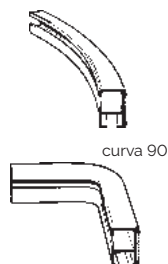

CURVE

curva ad ampio raggio



INSTALLAZIONE

| L cm |   | |
|-----------|---|-------|
| | P4081 | P3295 |
| → 70 | 2 | 2 |
| 71 → 110 | 3 | 3 |
| 111 → 165 | 4 | 4 |
| 166 → 215 | 5 | 5 |
| 216 → 265 | 6 | 6 |
| 266 → 340 | 7 | 7 |
| 341 → 365 | 8 | 8 |
| 366 → 400 | 9 | 9 |
| 401 → 445 | 10 | 10 |
| 446 → 500 | 11 | 11 |

SUPPLEMENTI A RICHIESTA

| | art. | desc. | colore | euro |
|---|---------|-------|--------|-------|
| Fettuccia | P755/C | al m. | | 1,41 |
| Fettuccia | P756/C | al m. | | 1,71 |
| Per ogni rocchetto supplementare; con nastro da 320 cm | P3295/1 | cad. | | 13,00 |
| Per ogni rocchetto supplementare; con filo da 320 cm | P3295/3 | cad. | | 11,97 |
| Supporti a parete 5,5 cm | P4084/C | cad. | | 3,97 |
| Supporti a parete 7 cm | P4085/C | cad. | | 4,22 |
| Curve a 90° - raggio 12 cm; | P3292/C | cad. | | 39,39 |
| Curve ad ampio raggio | P3293/C | al m. | | 36,47 |
| Frizione demoltiplicata P4520/P3298 (dove non prevista) | P4520/C | cad. | | 6,28 |
| Aste in fibra di vetro ϕ 4 mm | P4078/C | al m. | | 2,27 |
| Aste in alluminio ϕ 6 mm | P1854/C | al m. | | 3,81 |
| Aste in alluminio ϕ 8 mm | P1859/C | al m. | | 4,02 |

P444

| | | | | | | | | | | | | | | | |
|-----------|-------|-------|--------|--------|--------|--------|--------|--------|--------|--------|--------|--------|--------|--------|--------|
| LUNGHEZZA | 60 | 70 | 110 | 135 | 165 | 190* | 215* | 240* | 265* | 315* | 340* | 365* | 400* | 445* | 500* |
| PREZZO | 86,67 | 88,89 | 101,30 | 122,65 | 116,63 | 150,54 | 163,36 | 180,95 | 192,26 | 219,91 | 234,99 | 248,85 | 263,89 | 284,07 | 305,00 |
| N. CADUTE | 2 | 2 | 3 | 4 | 4 | 5 | 5 | 6 | 6 | 7 | 7 | 8 | 9 | 10 | 11 |

* Frizione

- art. P444/1 - Con frizione demoltiplicata art. P4520
- art. P444/2 - Con frizione diretta art. P3257
- art. P3624 - Con frizione demoltiplicata art. P3298

PROFILO ALLUMINIO 14X23 mm

| art. | imballo | colore | euro |
|------|---------|--------|-------|
| P414 | 72 m | bianco | 23,17 |

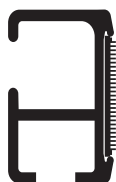

*lunghezza aste 6 m

FRIZIONE DEMOLTIPLICATA

| art. | imballo | colore | euro |
|-------|---------|--------|------------|
| P4520 | 15 pz. | | 29,18 cad. |



FRIZIONE DIRETTA

| art. | imballo | colore | euro |
|-------|---------|--------|------------|
| P3257 | 15 pz. | | 19,84 cad. |



FRIZIONE FRONTALE DEMOLTIPLICATA

| art. | imballo | colore | euro |
|-------|---------|--------|------------|
| P3298 | 15 pz. | | 20,60 cad. |



ROCCETTO AVVOLGINASTRO E FILO

| art. | imballo | colore | euro |
|-------|---------|--------|-----------|
| P3295 | 30 pz. | | 4,88 cad. |



ALBERINO DI COMANDO 5mm

| art. | imballo | colore | euro |
|-------|---------|--------------------|------|
| P3281 | 90m | argento/ grigio | 6,66 |

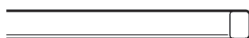

Lunghezza aste 4,5 m

RONDELLA ARRESTO CATENELLA

| art. | imballo | colore | euro |
|-------|---------|--------|------|
| P8236 | 100 pz. | | 0,35 |



CATENELLA PASSO 12 mm

| art. | imballo | colore | euro |
|-------|---------|--------|-----------|
| P1839 | 250m | bianco | 2,29 al m |



GIUNTO PER CATENELLA

| art. | imballo | colore | euro |
|-------|---------|--------|-----------|
| P3641 | 200 pz. | | 0,55 cad. |

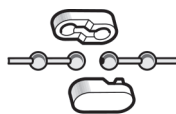

ANELLO CATENA CONTINUO

| art. | imballo | cm | euro |
|----------|---------|-----|-------|
| P3274/20 | 15 pz. | 200 | 12,79 |
| P3274/25 | 15 pz. | 250 | 13,80 |
| P3274/30 | 15 pz. | 300 | 14,63 |
| P3274/35 | 15 pz. | 350 | 15,74 |
| P3274/40 | 15 pz. | 400 | 16,87 |
| P3274/45 | 15 pz. | 450 | 19,93 |
| P3274/50 | 15 pz. | 500 | 21,92 |
| P3274/55 | 15 pz. | 550 | 24,00 |
| P3274/60 | 15 pz. | 600 | 26,14 |
| P3274/65 | 15 pz. | 700 | 29,53 |

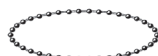

CONGIUNZIONE PER ALBERINO

| art. | imballo | colore | euro |
|-------|---------|--------|------|
| P3280 | 20 pz. | | 6,11 |

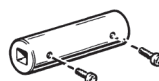

TENDICATENELLA

| art. | imballo | colore | euro |
|-------|---------|--------|------|
| P1304 | 10 pz. | bianco | 5,13 |



TENDICORDA DI SICUREZZA

| art. | imballo | colore | euro |
|-------|---------|--------|------|
| P3636 | 50 pz. | bianco | 3,15 |



TAPPO TERMINALE

| art. | imballo | colore | euro |
|-------|---------|--------|-----------|
| P4126 | 100 pz. | | 1,16 cad. |



PIATTINA PESO TENDA



| art. | imballo | mm | euro |
|-------|---------|--------|------|
| P4124 | 60 m. | 4 x 30 | 7,54 |
| P4125 | 60 m. | 4 x 40 | 8,81 |

*lunghezza aste 6m

NASTRO 5 mm

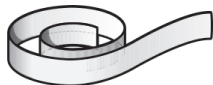

| art. | imballo | colore | euro |
|-------|---------|--------|------|
| P1931 | 150 m | bianco | 0,50 |
| P1931 | 150 m | trasp. | 0,63 |

*prezzo al m

AGGANCIO NASTRO REGOLABILE



| art. | imballo | colore | euro |
|-------|---------|--------|------|
| P4102 | 500 pz. | | 0,43 |

ANELLINO DA CUCIRE ø 9mm



| art. | imballo | colore | euro |
|-------|----------|--------|-------|
| P4168 | 1000 pz. | bianco | 30,18 |
| P4168 | 1000 pz. | trasp. | 25,13 |

*prezzo per 100 pz.

ANELLINO FONDOTENDA



| art. | imballo | colore | euro |
|-------|---------|--------|-----------|
| P4143 | 500 pz. | | 0,21 cad. |

CORDINA ø 1.2 mm



| art. | imballo | colore | euro |
|-------|---------|--------|-------|
| P4121 | 500 m | | 61,60 |

SNODO PER CURVE A 90°

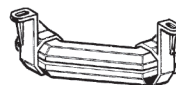

| art. | imballo | colore | euro |
|-------|---------|--------|-------|
| P3292 | 20 pz. | | 22,55 |

SNODO PER CURVE AMPIO RAGGIO



| art. | imballo | colore | euro |
|-------|---------|--------|-------|
| P3293 | 20 pz. | | 10,61 |

TONDINO



| art. | imballo | ø | euro |
|------|---------|-----------------|------|
| TT6 | 120 m | 6 mm AL | 4,02 |
| TT8 | 120 m | 8 mm AL | 3,81 |
| 4078 | 60 m | 4 mm Fibra 1,85 | |

P445

SISTEMA CURVABILE PER TENDE A PACCHETTO
CON AZIONAMENTO A CATENELLA



Dimensione profilo
L 14 mm
A 23 mm

Scala 1:1



Confezione standard con:

- art. P414 - Profilo alluminio veltrato
- art. P3281 - Alberino di comando 5 mm
- art. P4126 - Tappi terminali
- art. P3624 - Anello catena (Caduta 160-215 cm)
- art. P3257 - P4520 - Frizione diretta
- art. P3291 - Rocchetti
- art. P4139 - Supporto per nastro
- art. P1931 - Nastro 5 mm
- art. P4081 - Supporti a soffitto
- art. P4102 - Aggancio nastro
- art. P4124 - Pesotenda 4x30 mm

Sistema per tende a pacchetto medio leggere. Azionamento a catenella. Lavaggio rapido. Installazione a soffitto o a parete tramite mensole a sbalzo. Adatto per tende inclinate max 45°.

FISSAGGIO

art. P4081 Fissaggio a soffitto

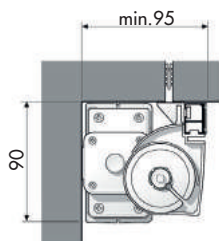

art. P4084 Fissaggio a parete

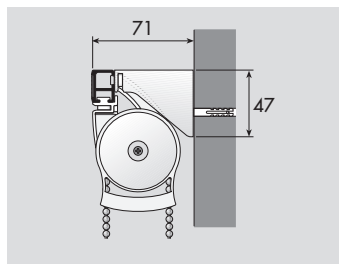

FISSAGGI OPZIONALI

art. P4085 Fissaggio a parete

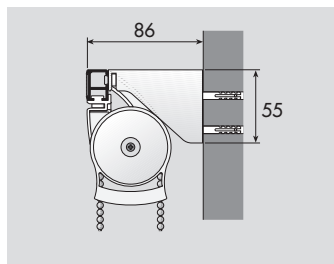

art. P4142 Fissaggio a parete

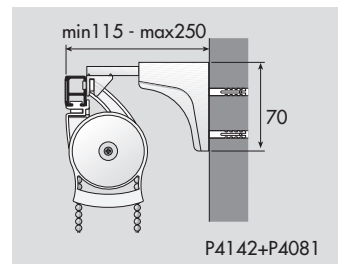

UTILIZZO

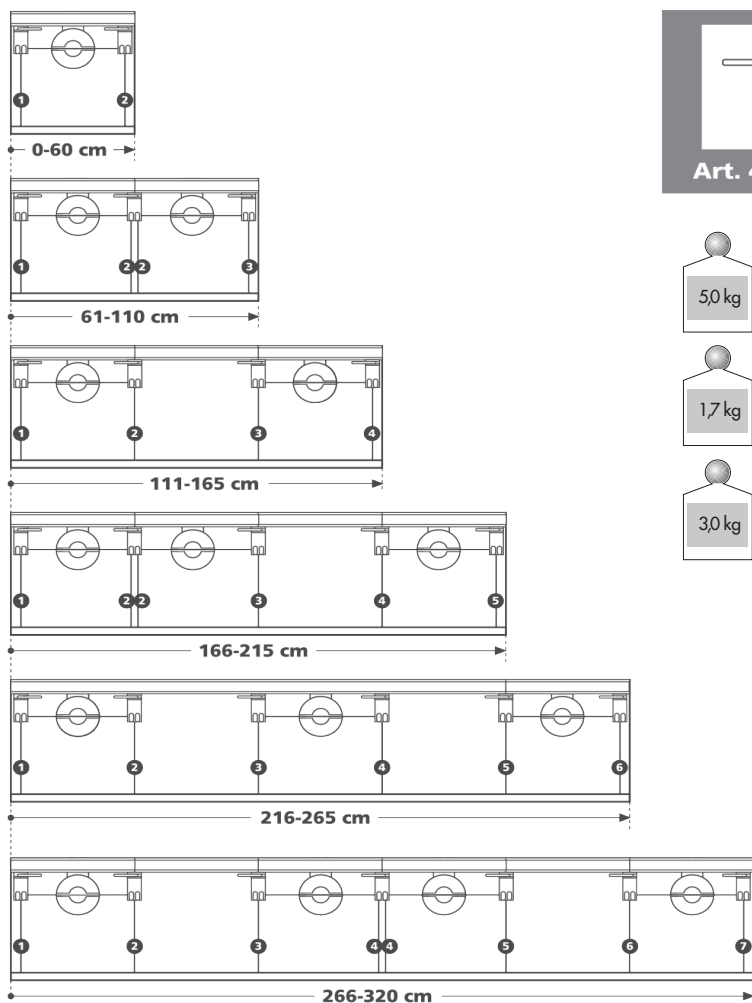

SISTEMA INCLINATO

Sistema inclinato

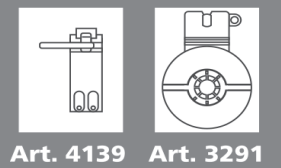
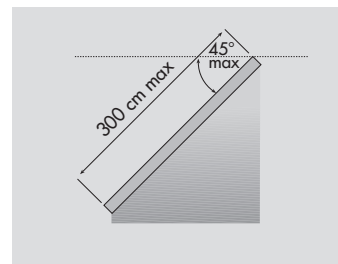

445/1
5,0 kg
L max: 320 cm
H max: 320 cm

445/2
1,7 kg
L max: 320 cm
H max: 320 cm

445/4
3,0 kg
L max: 320 cm
H max: 320 cm

SUPPLEMENTI A RICHIESTA

| | art. | desc. | colore | euro |
|--|---------|-------|--------|---------|
| Fettuccia | P755/C | al m. | | 1,41 |
| Fettuccia | P756/C | al m. | | 1,71 |
| Per ogni rocchetto supplementare | P3291 | cad. | | 16,07 |
| Supporti a parete 5,5 cm | P4084/C | cad. | | 3,97 |
| Supporti a parete 7 cm | P4085/C | cad. | | 4,22 |
| Gruppo motore | P3260 | cad. | | 1079,90 |
| Frizione demoltiplicata P4520/P3298 (dove non prevista) | P4520/C | cad. | | 6,28 |
| Frizione demoltiplicata per tende inclinate max L 300 cm | P3298 | cad. | | 20,59 |
| Aste in fibra di vetro ø 4 mm | P4078/C | al m. | | 2,27 |
| Aste in alluminio ø 6 mm | P1854/C | al m. | | 3,81 |
| Aste in alluminio ø 8 mm | P1859/C | al m. | | 4,02 |

P445

| LUNGHEZZA | 60 | 70 | 110 | 135 | 165 | 190* | 215* | 240* | 265* | 315* |
|---------------|-------|--------|--------|--------|--------|--------|--------|--------|--------|--------|
| PREZZO | 84,20 | 101,30 | 122,06 | 133,49 | 146,52 | 169,28 | 188,49 | 199,31 | 224,95 | 262,65 |
| NUMERO CADUTE | 2 | 3 | 3 | 4 | 4 | 5 | 5 | 6 | 6 | 7 |

* Frizione

- art. P445/1 - Con frizione demoltiplicata art. P4520
- art. P445/2 - Con frizione diretta art. P3257
- Sistema inclinato
- P445/4 - Con frizione demoltiplicata art. P3298 - Anello catena art. P3624

PROFILO ALLUMINIO 14X23 mm

| art. | imballo | colore | euro |
|------|---------|--------|-------|
| P414 | 72 m | bianco | 23,17 |

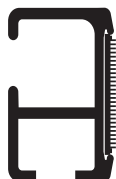

*lunghezza aste 6 m

FRIZIONE DEMOLTPLICATA



| art. | imballo | colore | euro |
|-------|---------|--------|------------|
| P4520 | 15 pz. | | 29,18 cad. |

FRIZIONE DIRETTA



| art. | imballo | colore | euro |
|-------|---------|--------|------------|
| P3257 | 15 pz. | | 19,84 cad. |

FRIZIONE FRONTALE DEMOLTPLICATA



| art. | imballo | colore | euro |
|-------|---------|--------|------------|
| P3298 | 15 pz. | | 20,60 cad. |

ROCCHETTO AVVOLGINASTRO E FILO



| art. | imballo | colore | euro |
|-------|---------|--------|------------|
| P3291 | 30 pz. | | 16,07 cad. |

SUPPORTO PER NASTRO

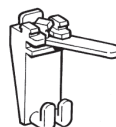

| art. | imballo | colore | euro |
|-------|---------|--------|-----------|
| P4139 | 100 pz. | | 1,91 cad. |

ALBERINO DI COMANDO 5mm



| art. | imballo | colore | euro |
|-------|---------|--------------------|------|
| P3281 | 90m | argento/ grigio | 6,66 |

Lunghezza aste 4,5 m

RONDELLA ARRESTO CATENELLA



| art. | imballo | colore | euro |
|-------|---------|--------|------|
| P8236 | 100 pz. | | 0,35 |

CATENELLA PASSO 12 mm



| art. | imballo | colore | euro |
|-------|---------|--------|-----------|
| P1839 | 250m | bianco | 2,29 al m |

GIUNTO PER CATENELLA

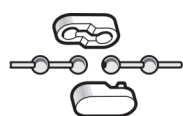

| art. | imballo | colore | euro |
|-------|---------|--------|-----------|
| P3641 | 200 pz. | | 0,55 cad. |

CATENELLA PASSO 6 mm



| art. | imballo | colore | euro |
|-------|---------|--------|------|
| P3644 | 250m | bianco | |

*prezzo per 100 m

ANELLO CATENA PASSO 6mm



| art. | imballo | colore | euro |
|-------|---------|--------|------|
| P3624 | 15 pz. | bianco | |

CONGIUNZIONE PER ALBERINO



| art. | imballo | colore | euro |
|-------|---------|--------|------|
| P3280 | 20 pz. | | 6,11 |

TENDICATENELLA



| art. | imballo | colore | euro |
|-------|---------|--------|------|
| P1304 | 10 pz. | bianco | 5,13 |

TENDICORDA DI SICUREZZA



| art. | imballo | colore | euro |
|-------|---------|--------|------|
| P3636 | 50 pz. | bianco | 3,15 |

TAPPO TERMINALE



| art. | imballo | colore | euro |
|-------|---------|--------|-----------|
| P4126 | 100 pz. | | 1,16 cad. |

PIATTINA PESO TENDA



| art. | imballo | mm | euro |
|-------|---------|--------|------|
| P4124 | 60 m. | 4 x 30 | 7,54 |
| P4125 | 60 m. | 4 x 40 | 8,81 |

*lunghezza aste 6m

NASTRO 5 mm

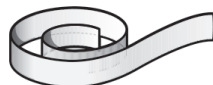

| art. | imballo | colore | euro |
|-------|---------|--------|------|
| P1931 | 150 m | bianco | 0,50 |
| P1931 | 150 m | trasp. | 0,63 |

*prezzo al m

AGGANCIO NASTRO REGOLABILE



| art. | imballo | colore | euro |
|-------|---------|--------|------|
| P4102 | 500 pz. | | 0,43 |

ANELLINO DA CUCIRE ø 9mm



| art. | imballo | colore | euro |
|-------|----------|--------|-------|
| P4168 | 1000 pz. | bianco | 30,18 |
| P4168 | 1000 pz. | trasp. | 25,13 |

*prezzo per 100 pz.

ANELLINO FONDOTENDA



| art. | imballo | colore | euro |
|-------|---------|--------|-----------|
| P4143 | 500 pz. | | 0,21 cad. |

CORDINA ø 1.2 mm



| art. | imballo | colore | euro |
|-------|---------|--------|-------|
| P4121 | 500 m | | 61,60 |

SNODO PER CURVE A 90°

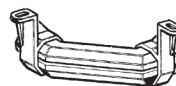

| art. | imballo | colore | euro |
|-------|---------|--------|-------|
| P3292 | 20 pz. | | 22,55 |

SNODO PER CURVE AMPIO RAGGIO



| art. | imballo | colore | euro |
|-------|---------|--------|-------|
| P3293 | 20 pz. | | 10,61 |

TONDINO



| art. | imballo | ø | euro |
|------|---------|------------|------|
| TT6 | 120 m | 6 mm AL | 4,02 |
| TT8 | 120 m | 8 mm AL | 3,81 |
| 4078 | 60 m | 4 mm Fibra | 1,85 |

SUPPORTO A SOFFITTO

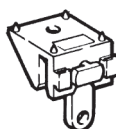

| art. | imballo | colore | euro |
|-------|---------|--------|------|
| P4081 | 100 pz. | | 2,21 |

SUPPORTO A PARETE 7.0 cm

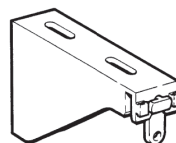

| art. | imballo | colore | euro |
|-------|---------|--------|------|
| P4085 | 50 pz. | | 4,22 |

MENSOLA A PARETE REGOLABILE

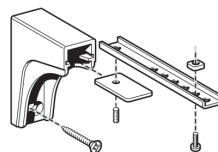

| art. | sporgenza | imballo | euro |
|-------|-----------|---------|------|
| P4142 | 10-15 cm | 10 pz. | 5,10 |
| P4142 | 16-20 cm | 10 pz. | 5,67 |
| P4142 | 21-25 cm | 10 pz. | 6,03 |

MOTORE DIGITALE 90-250 Vac

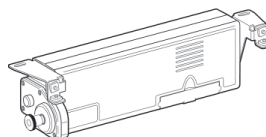

| art. | imballo | colore | euro |
|-------|---------|--------|---------|
| P3260 | 1 pz. | bianco | 1079,90 |

CAVO 3 x 0,35 mm²



| art. | imballo | colore | euro |
|---------|---------|--------|------|
| P5047/3 | 100 m. | bianco | 2,78 |

M2NET - TRASMETTITORE R. F.



| art. | imballo | colore | euro |
|-------|---------|-----------|--------|
| P5441 | 1 pz. | 1 sistema | 156,76 |
| P5444 | 1 pz. | 4 sistemi | 232,00 |

M2NET - TRASMETTITORE R. F. DA PARETE



| art. | imballo | colore | euro |
|-------|---------|-----------|--------|
| P5451 | 1 pz. | 1 sistema | 144,33 |
| P5454 | 1 pz. | 4 sistemi | 242,17 |

M2NET-TRASMETTITORE R.F. 100 CANALI



| art. | imballo | colore | euro |
|-------|---------|--------|--------|
| P5449 | 1 pz. | bianco | 463,40 |

P449

SISTEMA PER TENDE A PACCHETTO CON AZIONAMENTO A MOTORE INSTALLAZIONE UNIVERSALE - LAVAGGIO RAPIDO



Dimensione profilo
L 14 mm
A 23 mm

Scala 1:2



Sistema per tende a pacchetto con azionamento a motore; indicato per ambienti domestici o professionali

Confezione standard con:

- art. P414 - Profilo alluminio veltrato
- art. P3281 - Alberino di comando 5 mm
- art. P4126 - Tappi terminali
- art. P3260 - Motore digitale 90-250 Vac
- art. P3295 - Rocchetti
- art. P1931 - Nastro 5 mm
- art. P4081 - Supporti a soffitto
- art. P4102 - Aggancio nastro
- art. P4124 - Pesotenda 4x30 mm

FISSAGGIO

art. P4081 Fissaggio a soffitto

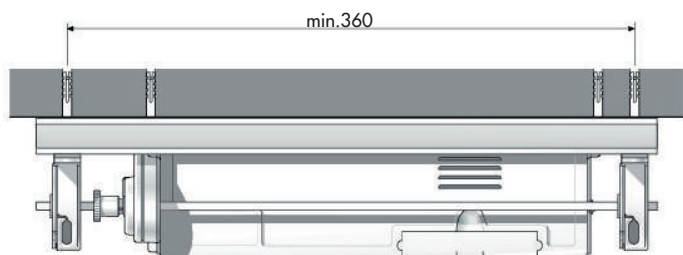

art. P4081 Fissaggio a soffitto

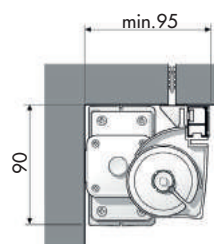

PORTATA

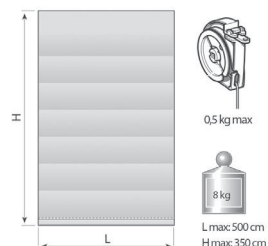

SUPPLEMENTI A RICHIESTA

| | art. | desc. | colore | euro |
|--|---------|-------|--------|--------|
| Fettuccia | P755/C | al m. | | 1,41 |
| Fettuccia trasparente | P756/C | al m. | | 1,71 |
| Curve a 90° - raggio 12 cm | P3292/1 | cad. | | 39,40 |
| Curve ad ampio raggio - raggio minimo 100 cm | P3293/3 | al m. | | 36,47 |
| Per ogni rocchetto supplementare; con nastro da 320 cm | P3295/1 | cad. | | 8,60 |
| Per ogni rocchetto supplementare; con filo da 320 cm | P3295/3 | cad. | | 7,31 |
| M2Net - Trasmettitore radio R.F. 1 sistema | P5441 | cad. | | 156,77 |
| M2Net - Trasmettitore radio R.F. 4 sistemi | P5444 | cad. | | 232,01 |
| M2Net - Trasmettitore radio R.F. 100 canali | P5449 | cad. | | 463,40 |
| M2Net - Pulsante digitale da parete 1 sistema | P5431 | cad. | | 81,89 |
| M2Net - Trasmettitore radio R.F. ULTRASLIM da parete 1 sistema | P5421 | cad. | | 134,16 |
| Aste in fibra di vetro ø 4 mm | P4078/C | al m. | | 1,91 |
| Aste in alluminio ø 6 mm | P1854/C | al m. | | 4,02 |
| Aste in alluminio ø 8 mm | P1859/C | al m. | | 3,81 |

Mensole a parete regolabili - ref. P4142/10/16/21

P449

| | | | | | | | | | | | | | | |
|-----------|----------|----------|----------|----------|----------|----------|----------|----------|----------|----------|----------|----------|----------|----------|
| LUNGHEZZA | 85 | 121 | 135 | 165 | 190 | 215 | 240 | 265 | 315 | 340 | 365 | 400 | 445 | 500 |
| PREZZO | 1.111,63 | 1.120,23 | 1.145,36 | 1.158,99 | 1.181,20 | 1.196,55 | 1.220,29 | 1.233,06 | 1.261,03 | 1.275,71 | 1.297,49 | 1.332,72 | 1.384,22 | 1.522,70 |
| N. CADUTE | 2 | 3 | 4 | 4 | 5 | 5 | 6 | 6 | 7 | 7 | 8 | 9 | 10 | 11 |

PROFILO ALLUMINIO 14X23 mm

| art. | imballo | colore | euro |
|------|---------|--------|-------|
| P414 | 72 m | bianco | 23,17 |

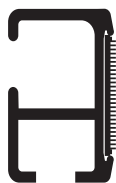

*lunghezza aste 6 m

ROCCETTO AVVOLGINASTRO E FILO

| art. | imballo | colore | euro |
|-------|---------|--------|-----------|
| P3295 | 30 pz. | | 4,88 cad. |



ALBERINO DI COMANDO 5mm

| art. | imballo | colore | euro |
|-------|---------|--------------------|------|
| P3281 | 90m | argento/ grigio | 6,66 |



Lunghezza aste 4,5 m

RONDELLA ARRESTO CATENELLA

| art. | imballo | colore | euro |
|-------|---------|--------|------|
| P8236 | 100 pz. | | 0,35 |



CATENELLA PASSO 12 mm

| art. | imballo | colore | euro |
|-------|---------|--------|-----------|
| P1839 | 250m | bianco | 2,29 al m |



GIUNTO PER CATENELLA

| art. | imballo | colore | euro |
|-------|---------|--------|-----------|
| P3641 | 200 pz. | | 0,55 cad. |

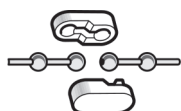

CATENELLA PASSO 6 mm

| art. | imballo | colore | euro |
|-------|---------|--------|------|
| P3644 | 250m | bianco | |



*prezzo per 100 m

ANELLO CATENA PASSO 6mm

| art. | imballo | colore | euro |
|-------|---------|--------|------|
| P3624 | 15 pz. | bianco | |

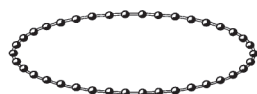

CONGIUNZIONE PER ALBERINO

| art. | imballo | colore | euro |
|-------|---------|--------|------|
| P3280 | 20 pz. | | 6,11 |



TENDICATENELLA

| art. | imballo | colore | euro |
|-------|---------|--------|------|
| P1304 | 10 pz. | bianco | 5,13 |



TENDICORDA DI SICUREZZA

| art. | imballo | colore | euro |
|-------|---------|--------|------|
| P3636 | 50 pz. | bianco | 3,15 |



TAPPO TERMINALE

| art. | imballo | colore | euro |
|-------|---------|--------|-----------|
| P4126 | 100 pz. | | 1,16 cad. |



PIATTINA PESO TENDA

| art. | imballo | mm | euro |
|-------|---------|--------|------|
| P4124 | 60 m. | 4 x 30 | 7,54 |
| P4125 | 60 m. | 4 x 40 | 8,81 |



*lunghezza aste 6m

NASTRO 5 mm

| art. | imballo | colore | euro |
|-------|---------|--------|------|
| P1931 | 150 m | bianco | 0,50 |
| P1931 | 150 m | trasp. | 0,63 |



*prezzo al m

AGGANCIO NASTRO REGOLABILE

| art. | imballo | colore | euro |
|-------|---------|--------|------|
| P4102 | 500 pz. | | 0,43 |



ANELLINO DA CUCIRE ø 9mm

| art. | imballo | colore | euro |
|-------|----------|--------|-------|
| P4168 | 1000 pz. | bianco | 30,18 |
| P4168 | 1000 pz. | trasp. | 25,13 |



*prezzo per 100 pz.

ANELLINO FONDOTENDA

| art. | imballo | colore | euro |
|-------|---------|--------|-----------|
| P4143 | 500 pz. | | 0,21 cad. |



CORDINA ø 1,2 mm

| art. | imballo | colore | euro |
|-------|---------|--------|-------|
| P4121 | 500 m | | 61,60 |



SNODO PER CURVE A 90°

| art. | imballo | colore | euro |
|-------|---------|--------|-------|
| P3292 | 20 pz. | | 22,55 |

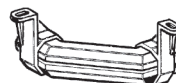

SNODO PER CURVE AMPIO RAGGIO



| art. | imballo | colore | euro |
|-------|---------|--------|-------|
| P3293 | 20 pz. | | 10,61 |

TONDINO



| art. | imballo | ∅ | euro |
|------|---------|------------|------|
| TT6 | 120 m | 6 mm AL | 4,02 |
| TT8 | 120 m | 8 mm AL | 3,81 |
| 4078 | 60 m | 4 mm Fibra | 1,85 |

SUPPORTO A SOFFITTO

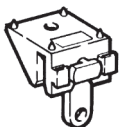

| art. | imballo | colore | euro |
|-------|---------|--------|------|
| P4081 | 100 pz. | | 2,21 |

SUPPORTO A PARETE 7,0 cm

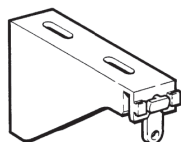

| art. | imballo | colore | euro |
|-------|---------|--------|------|
| P4085 | 50 pz. | | 4,22 |

MENSOLA A PARETE REGOLABILE

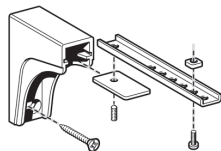

| art. | sporgenza | imballo | euro |
|-------|-----------|---------|------|
| P4142 | 10-15 cm | 10 pz. | 5,10 |
| P4142 | 16-20 cm | 10 pz. | 5,67 |
| P4142 | 21-25 cm | 10 pz. | 6,03 |

MOTORE DIGITALE 90-250 Vac

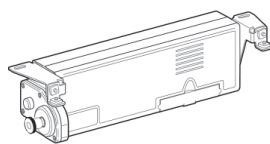

| art. | imballo | colore | euro |
|-------|---------|--------|---------|
| P3260 | 1 pz. | bianco | 1079,90 |

CAVO 3 x 0,35 mm²



| art. | imballo | colore | euro |
|---------|---------|--------|------|
| P5047/3 | 100 m. | bianco | 2,78 |

M2NET - TRASMETTITORE R. F.



| art. | imballo | | euro |
|-------|---------|-----------|--------|
| P5441 | 1 pz. | 1 sistema | 156,76 |
| P5444 | 1 pz. | 4 sistemi | 232,00 |

M2NET - TRASMETTITORE R. F. DA PARETE



| art. | imballo | | euro |
|-------|---------|-----------|--------|
| P5451 | 1 pz. | 1 sistema | 144,33 |
| P5454 | 1 pz. | 4 sistemi | 242,17 |

M2NET-TRASMETTITORE R.F. 100 CANALI



| art. | imballo | colore | euro |
|-------|---------|--------|--------|
| P5449 | 1 pz. | bianco | 463,40 |

P435/1

SISTEMA COMPATTO PER TENDE A PACCHETTO
CON AZIONAMENTO A CATENELLA



Dimensione profilo
L 32 mm
A 29 mm

Scala 1:1



Installazione universale - Lavaggio rapido

Confezione standard con:

- art. 435/VB - Profilo alluminio veltrato
- art. 3281 - Alberino di comando 5 mm
- art. 3266 - Tappi terminali
- art. 3269 - Set motore finecorsa
- art. 5135 - Ricevitore R.F. 24 Vdc
- art. 3261 - Rocchetti
- art. 4123 - Corda 1,4 mm
- art. 3278 - Supporti universali
- art. 4143 - Anello fondotenda
- art. 4124/B - Pesotenda 4x30 mm

FISSAGGI

art. P8152 Fissaggio a soffitto

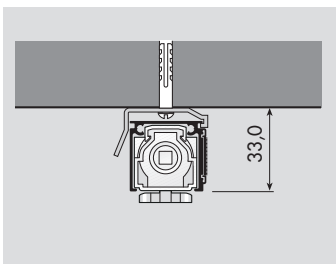

art. P8051 Fissaggio a soffitto

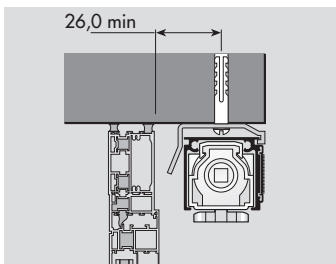

art. P3278 Fissaggio a parete

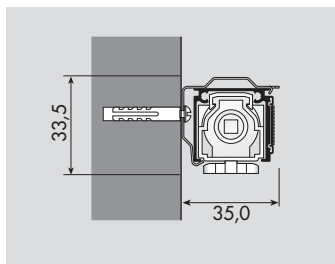

SUPPORTI

| L cm | | |
|-----------|-------|-------|
| | P3279 | P3272 |
| → 60 | 2 | 2 |
| 61 → 110 | 3 | 3 |
| 111 → 165 | 4 | 4 |
| 166 → 215 | 5 | 5 |
| 216 → 265 | 6 | 6 |
| 266 → 340 | 7 | 7 |
| 341 → 365 | 8 | 8 |
| 366 → 400 | 9 | 9 |

FISSAGGI OPZIONALI

ART. P4142 Fissaggio a parete

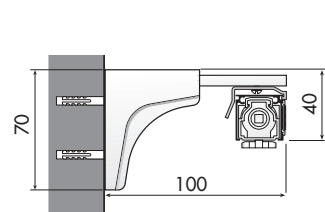

PORTATA

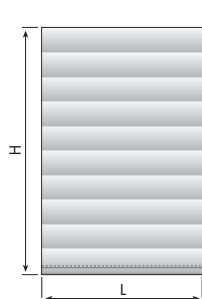

435/1
L max: 190 cm
H max: 200 cm

435/2
L max: 165 cm
H max: 150 cm

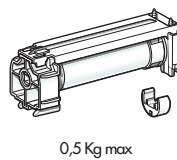

SUPPORTI

| L cm | | |
|-----------|-------|-------|
| | P3279 | P4191 |
| → 60 | 2 | 2 |
| 61 → 110 | 3 | 3 |
| 111 → 165 | 4 | 4 |
| 166 → 215 | 5 | 5 |
| 216 → 265 | 6 | 6 |
| 266 → 340 | 7 | 7 |
| 341 → 365 | 8 | 8 |
| 366 → 400 | 9 | 9 |

SUPPLEMENTI A RICHIESTA

| | art. | desc. | colore | euro |
|----------------------------------|-------|-------|--------|-------|
| Fettuccia | P755 | al m | | 0,90 |
| Fettuccia | P756 | al m | | 1,10 |
| Fettuccia | P4130 | al m | | 1,47 |
| Per ogni rocchetto supplementare | P4191 | cad. | | 2,37 |
| Supporto universale in acciaio | P3279 | cad. | | 1,56 |
| Tendicatenella | P3632 | cad. | | 2,38 |
| Aste in fibra di vetro ø 4 mm | P4078 | al m | | 1,74 |
| Aste in alluminio ø 6 mm | P1854 | al m | | 7,76 |
| Aste in alluminio ø 8 mm | P1859 | al m | | 8,67 |
| Anello catena passo 6 mm | P3624 | cad. | | 30,57 |

Mensole a parete regolabili / Adjustable wall supports - ref. 4142/10/16/21

vedere accessori

P35/2 - Frizione diretta

| | | | | | | | | | | | |
|-----------|-------|-------|-------|-------|-------|-------|--------|--------|--------|-------|--------|
| LUNGHEZZA | 60 | 70 | 80 | 90 | 100 | 110 | 120 | 130 | 140 | 150 | 160 |
| PREZZO | 66,40 | 80,50 | 84,60 | 88,75 | 89,50 | 93,50 | 105,10 | 111,10 | 115,25 | 121,0 | 131,50 |
| N. CADUTE | 2 | 3 | 4 | 4 | 5 | 5 | 6 | 6 | 7 | 7 | 8 |

P435/1 - Frizione demoltiplicata

| | | | | | | | | | | |
|-------------|-------|-------|-------|-------|-------|--------|--------|--------|--------|--------|
| LUNGHEZZA | 60 | 70 | 80 | 90 | 100 | 110 | 120 | 140 | 165 | 190 |
| PREZZO | 73,65 | 89,40 | 93,90 | 98,55 | 99,30 | 103,80 | 116,65 | 127,80 | 162,50 | 188,15 |
| N. SUPPORTI | 2 | 3 | 4 | 4 | 5 | 5 | 6 | 6 | 7 | 7 |

PROFILO ALLUMINIO VELCRATO 32X29 mm

| art. | imballo | colore | euro |
|----------|---------|--------|-------|
| P4357-VB | 54 m | bianco | 23,55 |

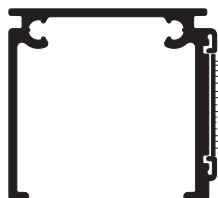

*lunghezza aste 4,5 m

GRUPPO COMANDO FRIZIONATO

| art. | imballo | colore | euro |
|-------|---------|--------|-------|
| P3264 | 15 pz. | | 11,75 |

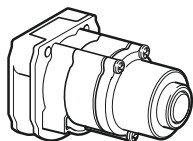

FRIZIONE DEMOLTIPLICATA

| art. | imballo | colore | euro |
|-------|---------|--------|-------|
| P3263 | 15 pz. | | 20,25 |

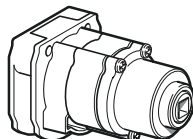

TAPPO TERMINALE

| art. | imballo | colore | euro |
|-------|---------|--------|-----------|
| P3266 | 50 pz. | | 2,15 cad. |

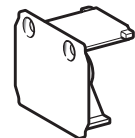

ALBERINO DI COMANDO 5mm

| art. | imballo | colore | euro |
|-------|---------|--------------------|------|
| P3281 | 90m | argento/ grigio | 6,66 |

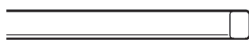

Lunghezza aste 4,5 m

ROCCHETTO LAVAGGIO RAPIDO

| art. | imballo | colore | euro |
|-------|---------|--------|-----------|
| P3261 | 30pz. | | 2,58 cad. |

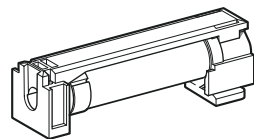

*lunghezza aste 4,5 m

ROCCHETTO LAVAGGIO RAPIDO

| art. | imballo | colore | euro |
|-------|---------|--------|------|
| P3265 | 30 pz. | | 2,40 |

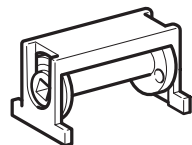

MENSOLA A PARETE REGOLABILE

| art. | sporgenza | imballo | euro |
|-------|-----------|---------|------|
| P4142 | 10-15 cm | 10 pz. | 5,10 |
| P4142 | 16-20 cm | 10 pz. | 5,67 |
| P4142 | 21-25 cm | 10 pz. | 6,03 |

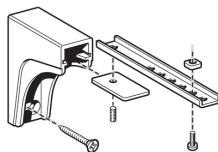

SUPPORTO A SCATTO IN ACCIAIO

| art. | imballo | colore | euro |
|-------|---------|--------|-----------|
| P8051 | 200 pz. | | 1,45 cad. |



SUPPORTO UNIVERSALE IN ACCIAIO

| art. | imballo | colore | euro |
|-------|---------|--------|-----------|
| P3278 | 100 pz. | | 3,20 cad. |

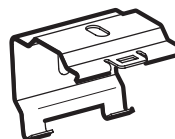

PIATTINA PESO TENDA

| art. | imballo | mm | euro |
|-------|---------|------|------|
| P4176 | 54/60 m | 3x25 | 6,08 |
| P4124 | 54/60 m | 4x30 | 7,88 |
| P4125 | 54/60 m | 4x40 | 9,50 |



*lunghezza aste 4,5/6,0 m

ANELLO CATENA PASSO 6mm

| art. | imballo | colore | euro |
|-------|---------|--------|------|
| P3624 | 15 pz. | bianco | |



GIUNTO PER CATENELLA

| art. | imballo | colore | euro |
|-------|---------|--------|-----------|
| P3641 | 200 pz. | | 0,55 cad. |

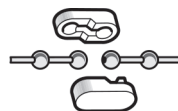

RONDELLA ARRESTO CATENELLA

| art. | imballo | colore | euro |
|-------|---------|--------|------|
| P8236 | 100 pz. | | 0,35 |



TENDICATENELLA

| art. | imballo | colore | euro |
|-------|---------|--------------------|-----------|
| P3632 | 10 pz. | argento/ grigio | 2,38 cad. |
| P3632 | 10 pz. | bianco | 2,38 cad. |
| P3632 | 10 pz. | nero | 2,38 cad. |



TENDICORDA DI SICUREZZA

| art. | imballo | colore | euro |
|-------|---------|--------|------|
| P3636 | 50 pz. | bianco | 3,15 |



CORDINA ø 1,4 mm

| art. | imballo | colore | euro |
|-------|---------|--------|-------|
| P4123 | 1000 m | bianco | 24,06 |



*prezzo per 100m

P440/1-2

SISTEMA COMPATTO PER TENDE A PACCHETTO



Dimensione profilo
L 40 mm
A 40 mm

Scala 1:1

Confezione standard con:

- art. 440/B - Profilo alluminio veltrato
- art. 3281 - Alberino di comando 5 mm
- art. 3266 - Tappi terminali/End plugs
- art. 3624.. - Anello catena (Caduta 160-215 cm)
- art. 4190-4193 - Frizione
- art. 4191 - Rocchetti
- art. 1931 - Nastro 5 mm
- ref. 3278 - Supporti universali
- ref. 4102 - Aggancio nastro regolabile
- ref. 4124/B - Pesotenda 4x30 mm

Sistema compatto per tende a pacchetto indicato per ambienti domestici o professionali

FISSAGGI

art. P8051 Fissaggio a soffitto

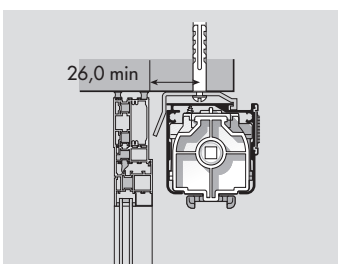

art. P3279 Fissaggio a parete

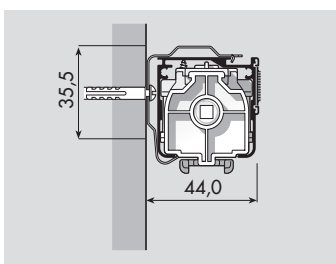

art. P3279 Fissaggio a soffitto

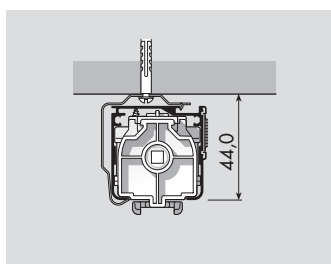

FISSAGGI OPZIONALI

art. P3279 Fissaggio a parete

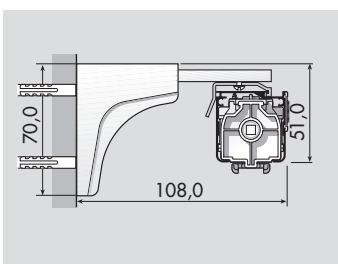

PORTATA

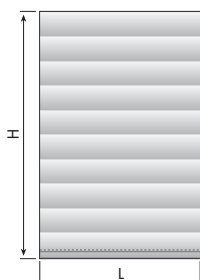

440/1
6,0 kg
L max: 500 cm
H max: 300 cm

440/2
3,0 kg
L max: 400 cm
H max: 300 cm

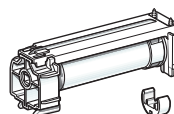

Portata max ogni singolo rocchetto 0,5 Kg

SUPPLEMENTI A RICHIESTA

| | art. | desc. | colore | euro |
|----------------------------------|-------|-------|--------|----------------|
| Per ogni rocchetto supplementare | P3272 | cad. | | 6,55 |
| Tendicatenella | P1304 | cad. | | 5,15 |
| Aste in fibra di vetro ø 4 mm | P4078 | al m | | 2,20 |
| Aste in alluminio ø 6 mm | P1854 | al m | | 3,70 |
| Aste in alluminio ø 8 mm | P1859 | al m | | 3,90 |
| Mensole a parete regolabili | | | | vedi accessori |

P440/2 - Frizione diretta

| | | | | | | | | | |
|-----------|--------|--------|--------|--------|--------|--------|--------|--------|--------|
| LUNGHEZZA | 60 | 110 | 135 | 165 | 190 | 215 | 240 | 265 | 315 |
| PREZZO | 110,70 | 134,00 | 155,90 | 176,90 | 200,30 | 215,00 | 242,75 | 260,10 | 300,50 |

P440/1 - Frizione demoltiplicata

| | | | | | | | | | | | | |
|-----------|--------|--------|--------|--------|--------|--------|--------|--------|--------|--------|--------|--------|
| LUNGHEZZA | 60 | 110 | 135 | 165 | 190 | 215 | 240 | 265 | 315 | 340 | 365 | 400 |
| PREZZO | 115,35 | 138,85 | 165,10 | 184,60 | 210,60 | 221,80 | 247,05 | 264,25 | 306,70 | 324,00 | 349,20 | 381,40 |

PROFILO ALLUMINIO VELCRATO 40X40 mm

| art. | imballo | colore | euro |
|------|---------|--------|-------|
| P440 | 36 m | bianco | 26,70 |

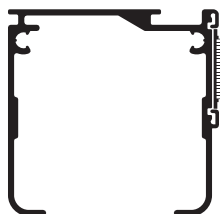

*lunghezza aste 4,5 m

GRUPPO COMANDO FRIZIONATO

| art. | imballo | colore | euro |
|-------|---------|--------|------------|
| P4190 | 15 pz. | | 14,70 cad. |

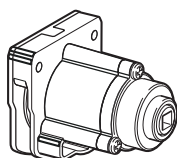

FRIZIONE DEMOLTIPPLICATA

| art. | imballo | colore | euro |
|-------|---------|--------|------------|
| P4193 | 15 pz. | | 20,25 cad. |

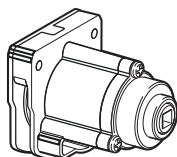

ALBERINO DI COMANDO 5mm

| art. | imballo | colore | euro |
|-------|---------|--------------------|------|
| P3281 | 90m | argento/ grigio | 6,66 |



Lunghezza aste 4,5 m

ROCCETTO LAVAGGIO RAPIDO

| art. | imballo | colore | euro |
|-------|---------|--------|-----------|
| P3272 | 30pz. | | 6,35 cad. |

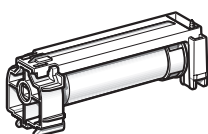

CORDINA ø 1,2 mm

| art. | imballo | colore | euro |
|--------|---------|--------|-------|
| PK4123 | 1000 m | bianco | 25,53 |



*prezzo per 100m

SUPPORTO A SCATTO IN ACCIAIO

| art. | imballo | colore | euro |
|-------|---------|--------|-----------|
| P8051 | 200 pz. | | 1,45 cad. |



SUPPORTO UNIVERSALE IN ACCIAIO

| art. | imballo | colore | euro |
|-------|---------|--------|------|
| P3279 | 100 pz. | | 3,20 |

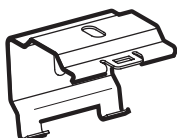

*prezzo per 100 pz

SUPPORTO UNIVERSALE IN ACCIAIO

| art. | imballo | colore | euro |
|-------|---------|--------|------|
| P3279 | 100 pz. | | 3,20 |

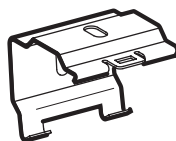

*prezzo per 100 pz

MENSOLA A PARETE REGOLABILE

| art. | sporgenza | imballo | euro |
|-------|-----------|---------|------|
| P4142 | 10-15 cm | 10 pz. | 5,10 |
| P4142 | 16-20 cm | 10 pz. | 5,67 |
| P4142 | 21-25 cm | 10 pz. | 6,03 |

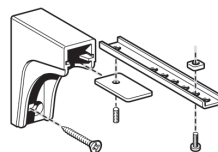

GIUNTO PER CATENELLA

| art. | imballo | colore | euro |
|-------|---------|--------|-----------|
| P3641 | 200 pz. | | 0,55 cad. |

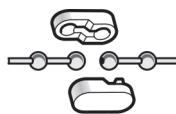

ANELLO CATENA PASSO 6mm

| art. | imballo | colore | euro |
|-------|---------|--------|------|
| P3624 | 15 pz. | bianco | |



RONDELLA ARRESTO CATENELLA

| art. | imballo | colore | euro |
|-------|---------|--------|------|
| P8236 | 100 pz. | | 0,35 |



TENDICATENA DI SICUREZZA

| art. | imballo | colore | euro |
|-------|---------|--------------------|------|
| P1303 | 50 pz. | argento- grigio | 4,45 |
| P1303 | 50 pz. | bianco | 4,45 |
| P1303 | 50 pz. | nero | 4,45 |

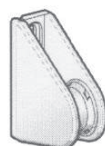

TENDICATENELLA DI SICUREZZA

| art. | imballo | colore | euro |
|-------|---------|--------|------|
| P1304 | 50 pz. | bianco | 5,10 |

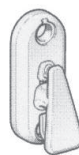

TENDICORDA DI SICUREZZA

| art. | imballo | colore | euro |
|-------|---------|--------|------|
| P3636 | 50 pz. | bianco | 3,15 |



PIATTINA PESO TENDA

| art. | imballo | mm | euro |
|-------|---------|------|------|
| P4176 | 54/60 m | 3x25 | 6,08 |
| P4124 | 54/60 m | 4x30 | 7,88 |
| P4125 | 54/60 m | 4x40 | 9,50 |



*lunghezza aste 4,5/6,0 m

P467/3

SISTEMA COMPATTO PER TENDE A PACCHETTO

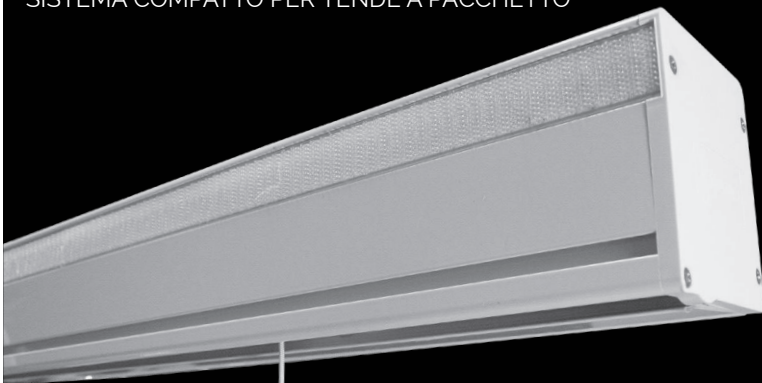

Sistema compatto per tende a pacchetto indicato per grandi dimensioni



Dimensione profilo
L 32 mm
A 29 mm

Scala 1:2

- Confezione standard con:
- art. 467/B - Profilo alluminio velcrato
 - art. 525 - Bandella velcrata
 - art. 1810 - Tubo alluminio ø 45 mm
 - art. 4402 - Terminali
 - art. 1805M35-1804M35 - Motore 230 Vac
 - art. 3273 - Rocchetto (con cm 50 corda)
 - art. 4027 - Chiavette di fissaggio
 - art. 4102 - Aggancio nastro regolabile
 - art. 4124/B - Pesotenda 4x30 mm

FISSAGGI

art. P8051 Fissaggio a soffitto

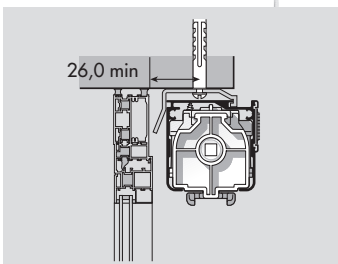

art. P4142 Fissaggio a soffitto

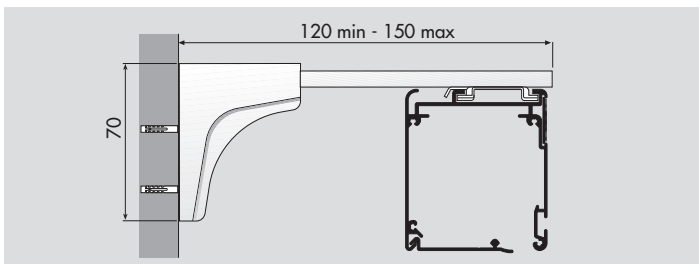

SUPPORTI

| L cm | P4027(L...) | P4401 | P3273 |
|-----------|-------------|-------|-------|
| + 60 | 2 | 2 | 2 |
| 61 → 110 | 3 | 3 | 3 |
| 111 → 165 | 4 | 4 | 4 |
| 166 → 215 | 5 | 5 | 5 |
| 216 → 265 | 6 | 6 | 6 |
| 266 → 340 | 7 | 7 | 7 |
| 341 → 365 | 8 | 8 | 8 |
| 366 → 400 | 9 | 9 | 9 |
| 401 → 445 | 10 | 10 | 10 |
| 446 → 500 | 11 | 11 | 11 |
| 501 → 550 | 12 | 12 | 12 |
| 551 → 600 | 13 | 13 | 13 |
| 601 → 650 | 14 | 14 | 14 |
| 651 → 695 | 15 | 15 | 15 |

FISSAGGIO TENDA

art. P4263 Fissaggio a soffitto

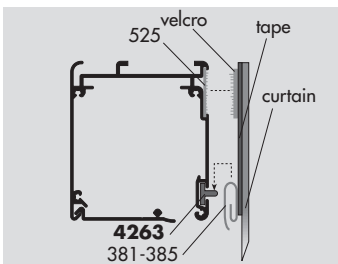

PORTATA



1804 M35
L max: 695 cm
H max: 550 c
20,0 kg

1805 M35
L max: 695 cm
H max: 550 c
8,0 kg

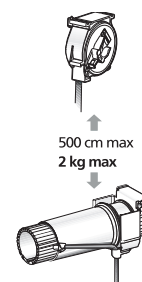

SUPPLEMENTI A RICHIESTA

| | art. | desc. | colore | euro |
|---|------------|-------|--------|------------------|
| Motore con ricevitore 6Nm/28Rpm R.F. integrato | C/1805M35R | cad. | | 89,26 |
| Motore con ricevitore 6Nm/28Rpm R.F. M2Net integrato | C/1805M35D | cad. | | 95,64 |
| Motore con ricevitore 13Nm/14Rpm R.F. integrato | C/1804M35R | cad. | | 93,73 |
| Motore con ricevitore 13Nm/14Rpm R.F. M2Net integrato | C/1804M35D | cad. | | 99,91 |
| Trasmettitori: vedi automatismi | | | | |
| Rocchetto supplementare (con 5 m di corda) | 3273/1 | cad. | | 6,44 |
| Rocchetto supplementare (senza corda) | 3273 | cad. | | 3,71 |
| Scivoli aggancio tenda | 4263/C | al m | | 0,61 |
| Supporto a parete con chiavetta | 1159/C | cad. | | 5,02 |
| Aste in fibra di vetro ø 4 mm | 4078/C | al m | | 1,74 |
| Aste in fibra di vetro ø 6 mm | 1854/C | al m | | 7,76 |
| Aste in alluminio ø 8 mm | 1859/C | al m | | 8,67 |
| Mensola acciaio bianca | | | | vedere accessori |
| Mensole a parete regolabili | | | | vedere accessori |

P467/3

| | | | | | | | | | | | | | | |
|-----------------|--------|--------|--------|--------|--------|--------|--------|--------|--------|--------|--------|---------|---------|---------|
| LUNGHEZZA | 85 | 120 | 135 | 165 | 190 | 215 | 240 | 265 | 315 | 340 | 365 | 400 | 445 | 500 |
| PREZZO | 590,20 | 635,40 | 660,20 | 685,00 | 723,25 | 827,85 | 855,80 | 883,80 | 939,75 | 958,30 | 995,55 | 1042,15 | 1174,20 | 1230,15 |
| NUMERO ROCHETTI | 2 | 3 | 4 | 4 | 5 | 5 | 6 | 6 | 7 | 7 | 8 | 9 | 10 | 11 |

| | | |
|-----------------|---------|---------|
| LUNGHEZZA | 550 | 600 |
| PREZZO | 1349,85 | 1408,75 |
| NUMERO ROCHETTI | 12 | 13 |

PROFILO ALLUMINIO VELCRATO 67X76 mm

| art. | imballo | colore | euro |
|--------|---------|--------|-------|
| P467/B | 34 m | bianco | 52,45 |

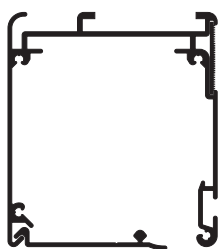

*lunghezza aste 6,0 m

PROFILO PVC VELCRATO

| art. | imballo | colore | euro |
|--------|---------|--------|------|
| P525/B | 54 pz. | bianco | 2,68 |

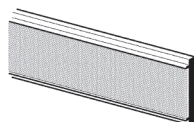

*lunghezza aste 4,5m

ALBERO DI COMANDO

| art. | imballo | colore | euro |
|-------|---------|--------|------|
| P5296 | 24 pz. | | 8,93 |



*lunghezza aste 6,0m

COPPIA TESTATE CASSONETTO

| art. | imballo | colore | euro |
|-------|---------|--------|------|
| P4402 | 20 pz. | | 1,98 |

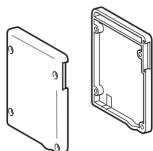

CHIAVETTA GIREVOLE

| art. | imballo | colore | euro |
|-------|---------|--------|------|
| P4027 | 100 pz. | | 2,08 |

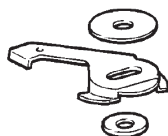

MOTORE 6 NM / 28 RPM Ø35 MM 230 VAC

| art. | imballo | R.F. | euro |
|-----------|---------|---------------|--------|
| P1805M35 | 1 pz. | | 181,02 |
| P1805M35R | 1 pz. | R.F integrato | 216,79 |
| P1805M35D | 1 pz. | R.F - M2Net | 230,22 |

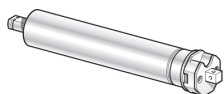

MOTORE 13 NM / 14 RPM Ø35 MM 230 VAC

| art. | imballo | R.F. | euro |
|-----------|---------|---------------|--------|
| P1804M35 | 1 pz. | | 198,79 |
| P1804M35R | 1 pz. | R.F integrato | 237,93 |
| P1804M35D | 1 pz. | R.F - M2Net | 252,35 |

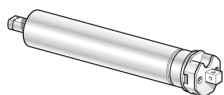

STAFFA SUPPORTO SISTEMA

| art. | imballo | colore | euro |
|-------|---------|--------|------|
| P3276 | 10 pz | | 4,33 |

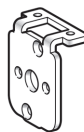

ROCHETTO AVVOLGITORE

| art. | imballo | colore | euro |
|-------|---------|--------|------|
| P3273 | 30 pz | | 5,36 |

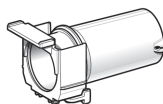

TUBO ALLUMINIO

| art. | imballo | colore | euro |
|-------|---------|--------|-------|
| P1810 | 24 pz | | 19,26 |

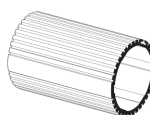

*lunghezza aste 6,0 m

SUPPORTO CALOTTA CON CUSCINETTO

| art. | imballo | colore | euro |
|-------|---------|--------|-------|
| P4187 | 1 pz | | 24,82 |



CALOTTA CON PERNO Ø 40

| art. | imballo | colore | euro |
|-------|---------|--------|------|
| P1131 | 10 pz | | 2,44 |



CORDA D'AZIONAMENTO

| art. | imballo | colore | euro |
|-------|---------|--------|-------|
| P3647 | 500 m | bianco | 10,82 |



*prezzo per 100m

TRASMETTITORE R.F.

| art. | imballo | colore | euro |
|-------|---------|------------|--------|
| P5143 | 1 pz. | 1 sistema | 50,34 |
| P5145 | 1 pz. | 5 sistemi | 53,65 |
| P5155 | 1 pz. | 15 sistemi | 102,20 |

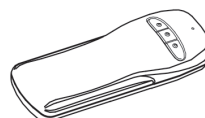

M2NET-TRASMETTITORE R.F. 100 CANALI

| art. | imballo | colore | euro |
|-------|---------|--------|--------|
| P5449 | 1 pz. | bianco | 463,40 |



P542/3/4/5

SISTEMA PER TENDE A PANNELLO

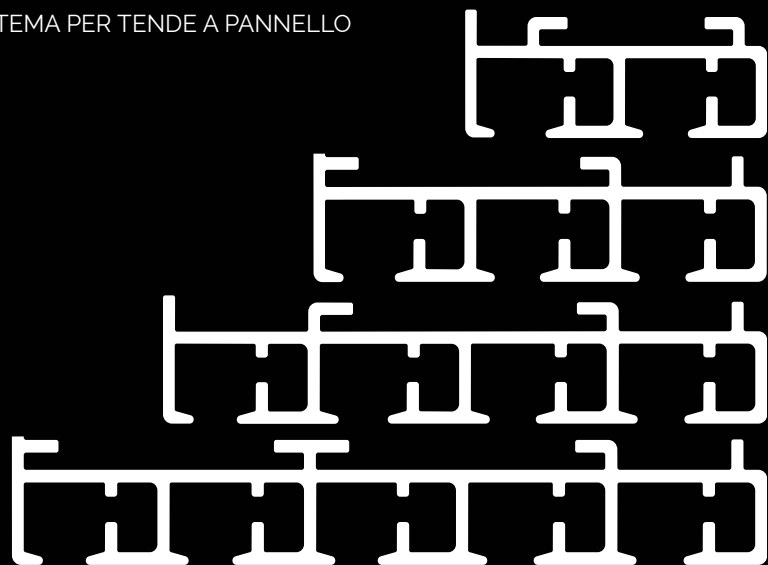

Dimensione profilo
L 41 mm
A 15 mm

Scala 1:1

Dimensione profilo
L 60 mm
A 15 mm

Scala 1:1

Dimensione profilo
L 80 mm
A 15 mm

Scala 1:1

Dimensione profilo
L 100 mm
A 15 mm

Scala 1:1

Confezione standard con:

- art. P542-3-4-5 - Profilo alluminio
- art. P4332 - Profilo velcrato in PVC
- art. P4094 - Terminale per 520
- art. P4202-3-4-5 - Tappi terminali
- art. P4209 - Angolare a "T"

- art. P4208 - Angolare a "L"
- art. P4161 - P4183 - Chiavetta di fissaggio
- art. P4393 - Corda \varnothing 3,2 mm
- art. P4482 - Fissacorda
- art. P4124 - Peso tenda 4x40 mm



Azionamento manuale a teli liberi, manuale con asta tiratenda e con corde.

P542: 2 canali - P543: 3 canali - P544: 4 canali - P545: 5 canali.

L'applicazione in parallelo di sistemi diversi permette la realizzazione delle più svariate soluzioni.

FISSAGGI

art. P4483 Fissaggio a soffitto P542

art. P4161 Fissaggio a soffitto P542
P543 - P544 - P545

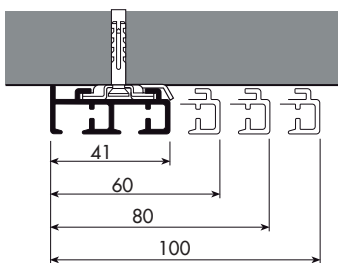

art. P4142 Fissaggio a parete

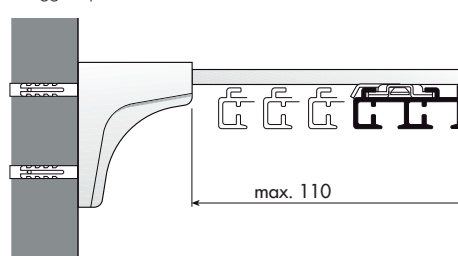

SUPPLEMENTI A RICHIESTA

| art. | desc. | colore | euro |
|------|-------|--------|------|
| | al m | | |

Profilo velcrato in alluminio

P542 - 2 vie

| LUNGHEZZA | 150 | 200 | 250 | 300 | 350 | 400 | 450 | 500 | 550 | 600 |
|-----------|--------|--------|--------|---------|--------|--------|--------|--------|--------|--------|
| STRAPPO | 108,25 | 135,30 | 166,15 | 191,75 | 216,50 | 240,50 | 264,60 | 301,58 | 315,75 | 338,35 |
| VINCOLATO | 126,10 | 149,30 | 183,30 | 211,50 | 238,90 | 265,40 | 281,95 | 315,50 | 348,50 | 373,30 |
| CORDA | 137,65 | 169,50 | 200,45 | 2341,05 | 260,90 | 290,00 | 305,95 | 326,10 | 365,00 | 390,50 |

P543 - 3 vie

| | | | | | | | | | | |
|-----------|--------|--------|--------|--------|--------|--------|--------|--------|--------|--------|
| LUNGHEZZA | 150 | 200 | 250 | 300 | 350 | 400 | 450 | 500 | 550 | 600 |
| STRAPPO | 128,70 | 147,90 | 170,90 | 197,25 | 236,70 | 262,95 | 289,20 | 322,10 | 367,95 | 394,30 |
| VINCOLATO | 141,15 | 167,15 | 193,10 | 216,30 | 259,50 | 288,40 | 317,30 | 345,50 | 378,50 | 401,50 |
| CORDA | 157,60 | 186,70 | 217,75 | 241,50 | 281,10 | 322,10 | 354,40 | 400,15 | 439,20 | 483,30 |

P544 - 4 vie

| | | | | | | | | | | |
|-----------|--------|--------|--------|--------|--------|--------|--------|--------|--------|--------|
| LUNGHEZZA | 150 | 200 | 250 | 300 | 350 | 400 | 450 | 500 | 550 | 600 |
| STRAPPO | 146,25 | 173,30 | 206,50 | 224,30 | 269,10 | 299,05 | 328,90 | 366,00 | 394,50 | 459,50 |
| VINCOLATO | 160,00 | 189,55 | 212,55 | 245,30 | 284,00 | 321,50 | 336,75 | 370,25 | 402,50 | 445,35 |
| CORDA | 177,40 | 204,00 | 235,70 | 264,15 | 288,25 | 318,75 | 349,50 | 370,75 | 401,20 | 427,35 |

P545 - 5 vie

| | | | | | | | | | | |
|-----------|--------|--------|--------|--------|--------|--------|--------|--------|--------|--------|
| LUNGHEZZA | 150 | 200 | 250 | 300 | 350 | 400 | 450 | 500 | 550 | 600 |
| STRAPPO | 170,95 | 202,45 | 255,61 | 270,00 | 314,55 | 349,50 | 384,45 | 418,50 | 457,50 | 487,50 |
| VINCOLATO | 174,40 | 206,50 | 238,30 | 267,40 | 320,15 | 356,25 | 391,40 | 444,10 | 498,75 | 531,95 |
| CORDA | 189,50 | 227,90 | 252,00 | 295,00 | 343,55 | 392,50 | 442,15 | 488,00 | 535,00 | 555,35 |

PROFILO ALLUMINIO 41 x 15 mm



*lunghezza aste 6 m

| art. | imballo | colore | euro |
|------|---------|--------------------|-------|
| P542 | 30m | alluminio satinato | 21,75 |
| P542 | 30m | bianco | 21,75 |

PROFILO ALLUMINIO 60 x 15 mm



*lunghezza aste 6 m

| art. | imballo | colore | euro |
|------|---------|--------------------|-------|
| P543 | 30m | alluminio satinato | 32,55 |
| P543 | 30m | bianco | 32,55 |

PROFILO ALLUMINIO 80 x 15 mm



*lunghezza aste 6 m

| art. | imballo | colore | euro |
|------|---------|--------------------|-------|
| P544 | 30m | alluminio satinato | 43,40 |
| P544 | 30m | bianco | 43,40 |

PROFILO ALLUMINIO 100 x 15 mm



*lunghezza aste 6 m

| art. | imballo | colore | euro |
|------|---------|--------------------|-------|
| P545 | 30m | alluminio satinato | 52,80 |
| P545 | 30m | bianco | 52,80 |

CONGIUNZIONE PROFILO

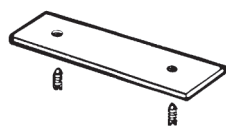

| art. | imballo | colore | euro |
|-------|---------|--------|------|
| P4098 | 10 pz. | | 4,60 |

COPPIA TAPPI DI ARRESTO PER P542

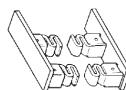

| art. | imballo | colore | euro |
|-------|---------|------------------|------|
| P4212 | 20 cp. | argento - grigio | 4,53 |
| P4212 | 20 cp. | bianco | 4,53 |

CONGIUNZIONE PROFILO P543-4-5



| art. | imballo | colore | euro |
|-------|---------|--------|------|
| P4224 | 10 pz. | | |

COPPIA TAPPI DI ARRESTO PER P543

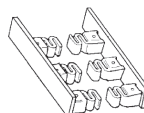

| art. | imballo | colore | euro |
|-------|---------|------------------|------|
| P4213 | 20 cp. | argento - grigio | 5,41 |
| P4213 | 20 cp. | bianco | 5,41 |

coppia guidacorda a rulli per P542

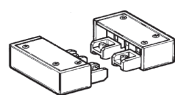

| art. | imballo | colore | euro |
|-------|---------|------------------|-------|
| P8202 | 10 cp. | argento - grigio | 12,72 |
| P8202 | 10 cp. | bianco | 12,72 |

COPIA GUIDACORDA A RULLI PER P543

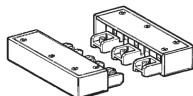

| art. | imballo | colore | euro |
|-------|---------|------------------|-------|
| P8203 | 8 cp. | argento - grigio | 18,03 |
| P8203 | 8 cp. | bianco | 18,03 |

COPIA GUIDACORDA A RULLI PER P544

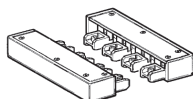

| art. | imballo | colore | euro |
|-------|---------|------------------|-------|
| P8204 | 10 cp. | argento - grigio | 19,42 |
| P8204 | 10 cp. | bianco | 19,42 |

COPIA GUIDACORDA A RULLI PER P545

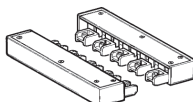

| art. | imballo | colore | euro |
|-------|---------|------------------|-------|
| P8205 | 8 cp. | argento - grigio | 25,49 |
| P8205 | 8 cp. | bianco | 25,49 |

VITE DI ARRESTO



| art. | imballo | colore | euro |
|-------|---------|--------|------|
| P4211 | 100 pz. | | 1,56 |

COPIA TAPPI DI ARRESTO PER 544

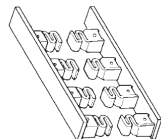

| art. | imballo | colore | euro |
|-------|---------|------------------|------|
| P8206 | 20 pz. | argento - grigio | 6,23 |
| P8206 | 20 pz. | bianco | 6,23 |

COPIA TAPPI DI ARRESTO PER P545

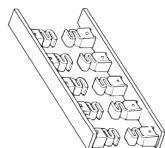

| art. | imballo | colore | euro |
|-------|---------|------------------|------|
| P8207 | 20 pz. | argento - grigio | 7,11 |
| P8207 | 20 pz. | bianco | 7,11 |

CHIAVETTA GIREVOLE



| art. | imballo | colore | euro |
|-------|---------|--------|--------|
| P4483 | 100 pz. | | 112,20 |

*prezzo per 100 pz.

CHIAVETTA GIREVOLE CON RONDELLA



| art. | imballo | colore | euro |
|-------|---------|--------|----------|
| P4161 | 100 pz. | | 118 cad. |

PROFILO PORTATELO IN PVC CON VELCRO

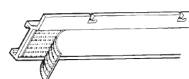

| art. | imballo | colore | euro |
|-------|---------|--------|--------|
| P4332 | 50 pz. | | 20,75* |

*prezzo per 100 pz.

PROFILO VELCRATO 6 x 24mm



| art. | imballo | colore | euro |
|------|---------|--------|-------|
| P520 | 60 m | bianco | 19,38 |

Lunghezza aste 6 m

ANGOLARE A" PER P520



| art. | imballo | colore | euro |
|-------|---------|--------|------|
| P4209 | 100 pz. | bianco | 1,29 |

ANGOLARE A"L" PER 520



| art. | imballo | colore | euro |
|-------|---------|--------|------|
| P4208 | 100 pz. | | 1,04 |

ANGOLARE A" PER P4332/P4337/P540



| art. | imballo | colore | euro |
|-------|---------|--------|------|
| P4333 | 100 pz. | trasp. | 1,29 |

ANGOLARE A"L" PER P4332/P4337/P540



| art. | imballo | colore | euro |
|-------|---------|--------|------|
| P4334 | 100 pz. | trasp. | 1,14 |

SUPPORTO A RULLI Noise Soft PER P520



| art. | imballo | colore | euro |
|-------|---------|--------|------|
| P4210 | 150 pz. | | 1,70 |

ASTA GUIDATENDA PLASTIFICATA BIANCA



| art. | imballo | cm. | euro |
|-------|---------|-----|------|
| PA/93 | 10 | 100 | 4,02 |
| PA/93 | 10 | 125 | 4,33 |
| PA/93 | 10 | 150 | 4,53 |
| PA/93 | 10 | 200 | 6,28 |

ASTA GUIDATENDA PLASTIFICATA TRASPARENTE



| art. | imballo | cm. | euro |
|--------|---------|-----|------|
| PA/900 | 10 | 100 | 4,53 |
| PA/900 | 10 | 125 | 5,36 |
| PA/900 | 10 | 150 | 6,18 |

CORDA 100% NYLON Ø 3 mm



| art. | imballo | colore | euro |
|-------|---------|--------|--------|
| P4393 | 500 m | bianco | 106,81 |

FISSACORDONE REGOLABILE

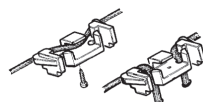

| art. | imballo | colore | euro |
|-------|---------|--------|------|
| P4482 | 50 pz. | | 3,81 |

RUOTA IN DELRIN PER P4332/P4337

| art. | imballo | cm. | euro |
|-------|---------|-----|------|
| P4141 | 100 | | 0,40 |



TAPPO TERMINALE

| art. | imballo | colore | euro |
|-------|---------|--------|-----------|
| P4094 | 200 pz. | | 1,06 cad. |

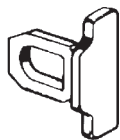

FIOCCO UNIVERSALE 60g

| art. | imballo | colore | euro |
|-------|---------|--------|-----------|
| P1580 | 25 pz. | bianco | 2,38 cad. |



TENDICORDA DI SICUREZZA

| art. | imballo | colore | euro |
|-------|---------|--------|------|
| P3636 | 50 pz. | bianco | 3,15 |



PIATTINA PESO TENDA

| art. | imballo | mm | euro |
|-------|---------|--------|------|
| P4124 | 60 m. | 4 x 30 | 7,54 |
| P4125 | 60 m. | 4 x 40 | 8,81 |



*lunghezza aste 6m

MENSOLA A PARETE REGOLABILE

| art. | sporgenza | imballo | euro |
|-------|-----------|---------|------|
| P4142 | 10-15 cm | 10 pz. | 5,10 |
| P4142 | 16-20 cm | 10 pz. | 5,67 |
| P4142 | 21-25 cm | 10 pz. | 6,03 |

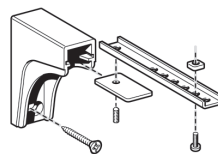

P1001

SISTEMA CURVABILE PER TENDE ARRICCIATE LEGGERE E MEDIE



Dimensione profilo
L 16 mm
A 22,6 mm

Scala 1:1

Confezione standard con:

- art. P1001 - Binario bianco
- art. PK100 - Coppia guide diritte bianche piastrina zincata vite a vista
- art. PK120 - Carrello plastica autolubrificata
- art. PK125 - Fermo per occhio
- art. PK145 - Scivolo in materozza
- art. PK160 - Supporto per soffitto a clip
- art. PK190 - Fiocco bianco
- art. PK210 - Cordone da 3,2 mm



Sistema ad uso principalmente domestico con azionamento a corda - corde guidate. Curvabile. Indicato per tende di peso medio. Installazione a: soffitto, a parete, libera sospensione.

FISSAGGIO

Fissaggio a soffitto

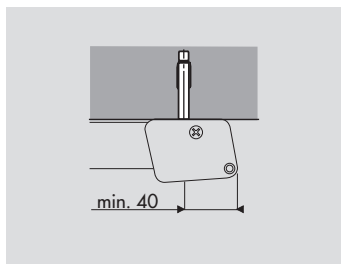

art. PK160 Fissaggio a soffitto a clip

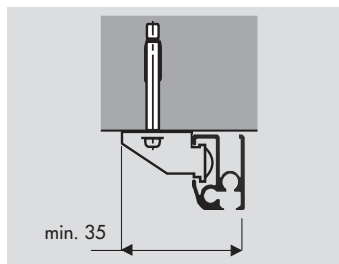

FISSAGGI OPZIONALI

art. PK175 Fissaggio a soffitto/parete a chiave 2 cm

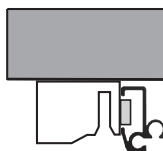

art. PK176 Fissaggio a soffitto/parete a chiave 6 cm

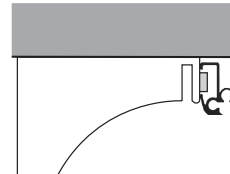

FISSAGGI OPZIONALI

art. PK240 Squadra estensibile bianca min. 11 - max. 16

art. PK245 Squadra estensibile bianca min. 16 - max. 24

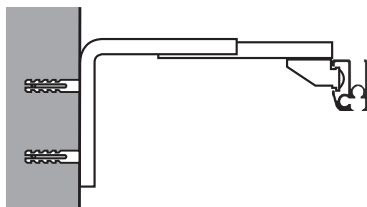

SCORREVOLI

art. PK145 Scivolo in materozza



CURVE

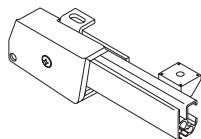

Diritto

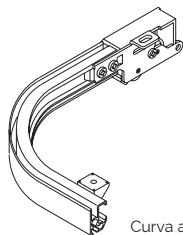

Curva a 90°

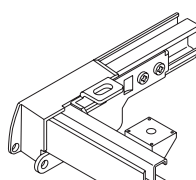

Angolo retto

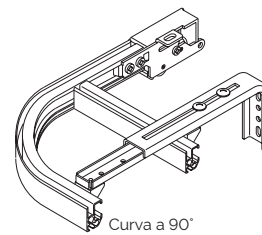

Curva a 90° + diritto

P1001

| | | | | | | | | | | | | | | |
|------------------|-------|-------|-------|-------|-------|-------|-------|-------|-------|-------|-------|-------|-------|-------|
| LUNGHEZZA | 140 | 160 | 180 | 200 | 220 | 240 | 260 | 280 | 300 | 320 | 340 | 360 | 380 | 400 |
| PREZZO con CORDA | 39,66 | 41,30 | 42,75 | 44,29 | 46,66 | 50,26 | 52,02 | 54,69 | 59,02 | 62,52 | 65,20 | 67,88 | 69,78 | 72,62 |
| PREZZO a STRAPPO | 24,62 | 28,17 | 31,67 | 35,23 | 38,73 | 42,28 | 45,84 | 49,34 | 52,84 | 56,34 | 59,89 | 62,32 | 66,95 | 70,45 |

| | | | | | | | | | | |
|----------------|-------|-------|-------|-------|-------|-------|--------|--------|--------|--------|
| LUNGHEZZA | 420 | 440 | 460 | 480 | 500 | 520 | 540 | 560 | 580 | 600 |
| PREZZO CORDA | 76,12 | 79,83 | 83,69 | 87,60 | 91,16 | 97,59 | 101,71 | 106,30 | 111,34 | 118,45 |
| PREZZO STRAPPO | 73,95 | 77,46 | 81,01 | 84,56 | 88,07 | 91,62 | 95,12 | 98,62 | 102,18 | 105,68 |

PROFILO IN ALLUMINIO 16 x 22,6 mm



| art. | imballo | colore | euro |
|-------|---------|--------|------|
| P1001 | 60 m | bianco | 7,57 |

Lunghezza aste 6 m

COPPIA GUIDE DIRITTE



| art. | imballo | colore | euro |
|-------|---------|--------|------|
| PK100 | 20 cp. | bianco | 7,78 |

COPPIA GUIDE AD ANGOLO

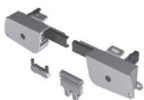

| art. | imballo | colore | euro |
|-------|---------|--------|------|
| PK110 | 20 cp. | bianco | 8,34 |

CARRELLO LAMA IN FERRO ZINCATO



| art. | imballo | colore | euro |
|-------|---------|---------|------|
| PK115 | 50 pz. | zincato | 1,91 |

CARRELLO IN PLASTICA



| art. | imballo | colore | euro |
|-------|---------|--------|------|
| PK120 | 50 pz. | bianco | 1,13 |

FERMO CON OCCHIOLO



| art. | imballo | colore | euro |
|-------|---------|--------|------|
| PK125 | 100 pz. | bianco | 0,46 |

GIUNZIONE CORDONE CON SPINA



| art. | imballo | colore | euro |
|-------|---------|--------|------|
| PK130 | 50 pz. | | 1,03 |

GIUNZIONE CORDONE IN ALLUMINIO E PLASTICA



| art. | imballo | colore | euro |
|-------|---------|--------|------|
| PK135 | 50 pz. | | 0,72 |

SCIVOLO IN MATEROZZA



| art. | imballo | colore | euro |
|-------|----------|--------|------------|
| PK145 | 1000 pz. | | 26,26 cad. |

*prezzo per 1000 pz.

SUPPORTO A SOFFITTO A CLIP - 2 cm



| art. | imballo | colore | euro |
|-------|---------|--------|------|
| PK160 | 100 pz. | | 0,55 |

SUPPORTO A SOFFITTO/PARETE A CHIAVETTA - 2 cm



| art. | imballo | colore | euro |
|-------|---------|--------|------|
| PK175 | 100 pz. | | 1,46 |

SUPPORTO A SOFFITTO/PARETE A CHIAVETTA - 6 cm



| art. | imballo | colore | euro |
|-------|---------|--------|------|
| PK176 | 100 pz. | | 1,60 |

TAPPO ANGOLARE PER BINARIO VELCRATO PICCOLO



| art. | imballo | colore | euro |
|-------|---------|--------|------|
| PK180 | 100 pz. | | 1,25 |

COPPIA TAPPI



| art. | imballo | colore | euro |
|-------|---------|--------|------|
| PK188 | 100 pz. | | 1,49 |

FIOCCO BIANCO



| art. | imballo | colore | euro |
|-------|---------|--------|------|
| PP190 | 50 pz. | bianco | 2,45 |

MENSOLA A PARETE REGOLABILE

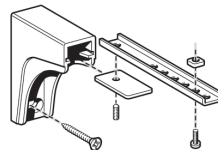

| art. | sporgenza | imballo | euro |
|-------|-----------|---------|------|
| P4142 | 10-15 cm | 10 pz. | 5,10 |
| P4142 | 16-20 cm | 10 pz. | 5,67 |
| P4142 | 21-25 cm | 10 pz. | 6,03 |

GUIDA DOPPIA CON PIASTRINA ZINCATA

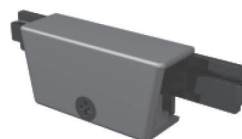

| art. | imballo | colore | euro |
|-------|---------|--------|-------|
| PK295 | 50 pz. | bianco | 22,66 |

CORDA 100% NYLON Ø 3 mm



| art. | imballo | colore | euro |
|-------|---------|--------|--------|
| P4393 | 500 m | bianco | 106,81 |

AGO PER GIUNZIONI CORDONE



| art. | imballo | colore | euro |
|-------|---------|---------|------|
| PK300 | 1 pz. | argento | 3,09 |

P1002

SISTEMA CURVABILE PER TENDE ARRICCIATE LEGGERE E MEDIE



Dimensione profilo
L 22,5 mm
A 21,0 mm

Scala 1:1



Confezione standard con:

- art. P1001 - Binario bianco
- art. PK100 - Coppia guide diritte bianche
- art. PK120 - Carrello plastica autolubrificata
- art. PK125 - Fermo per occhiolo
- art. PK145 - Scivolo in materozza
- art. PK160 - Supporto per soffitto a clip
- art. PK190 - Fiocco bianco
- art. PK210 - Cordone da 3,2 mm

Sistema ad uso principalmente domestico con azionamento a corda - corde guidate. Curvabile. Indicato per tende di peso medio. Installazione a: soffitto, a parete, libera sospensione.

FISSAGGI

Fissaggio a soffitto

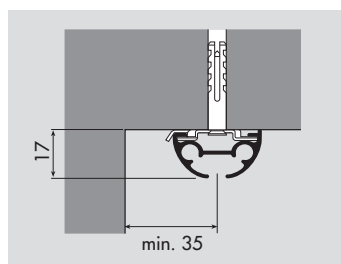

Fissaggio a soffitto

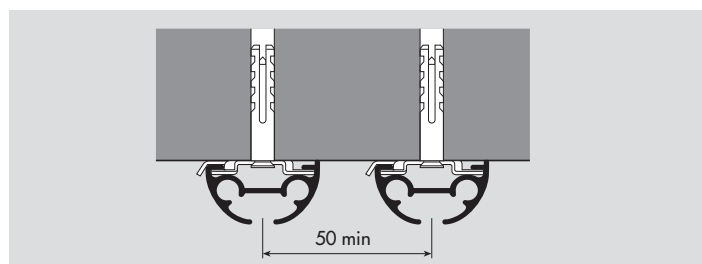

PORTATA

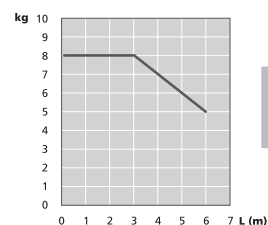

FISSAGGI

art. P4263 Scivolo in materozza



art. P4431 Scorrevole a rulli Noise Soft®



art. P4064 Scivolo con gancio inox



INSTALLAZIONE

| L cm | Number of rollers |
|-----------|-------------------|
| + 140 | 1 |
| 141 → 200 | 2 |
| 201 → 280 | 3 |
| 281 → 340 | 4 |
| 341 → 480 | 5 |
| 481 → 600 | 6 |

FISSAGGI

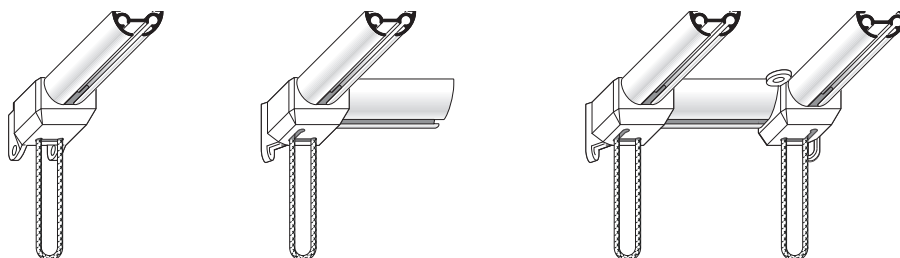

P1002

| LUNGHEZZA | 140 | 160 | 180 | 200 | 220 | 240 | 260 | 280 | 300 | 320 | 340 | 360 | 380 | 400 |
|----------------|-------|-------|-------|-------|-------|-------|-------|-------|-------|-------|-------|-------|-------|-------|
| PREZZO STRAPPO | 27,35 | 31,25 | 35,30 | 39,20 | 43,15 | 47,05 | 51,00 | 54,90 | 58,80 | 62,75 | 66,65 | 70,60 | 74,50 | 78,40 |
| PREZZO CORDA | 45,40 | 47,60 | 49,30 | 51,30 | 53,10 | 54,60 | 56,20 | 58,00 | 60,00 | 64,50 | 68,35 | 72,50 | 76,00 | 80,50 |

| LUNGHEZZA | 420 | 440 | 460 | 480 | 500 | 520 | 540 | 560 | 580 | 600 |
|----------------|-------|-------|-------|-------|--------|--------|--------|--------|--------|--------|
| PREZZO CORDA | 82,40 | 86,25 | 90,15 | 94,10 | 98,00 | 101,95 | 105,85 | 109,80 | 113,70 | 117,60 |
| PREZZO STRAPPO | 84,75 | 87,50 | 92,50 | 95,90 | 101,50 | 105,00 | 108,00 | 111,00 | 116,00 | 120,00 |

PROFILO ALLUMINIO 29X17 mm



| art. | imballo | colore | euro |
|-------|---------|--------|------|
| P1002 | 60 m | bianco | 9,30 |

*lunghezza aste 6m

MENSOLA A PARETE REGOLABILE

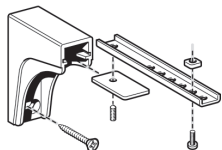

| art. | sporgenza | imballo | euro |
|-------|-----------|---------|------|
| P4142 | 10-15 cm | 10 pz. | 5,10 |
| P4142 | 16-20 cm | 10 pz. | 5,67 |
| P4142 | 21-25 cm | 10 pz. | 6,03 |

ARRESTO GIREVOLE



| art. | imballo | colore | euro |
|-------|---------|--------|------|
| P4277 | 100 pz. | | 1,00 |

SCIVOLO IN MATEROZZA



| art. | imballo | colore | euro |
|-------|----------|--------|-------|
| P4263 | 1000 pz. | | 8,09* |

*prezzo per 100 pz.

SCORREVOLE A RULLO



| art. | imballo | colore | euro |
|-------|---------|--------|------|
| P5005 | 100 pz. | bianco | 0,40 |

COPIA GIUDE DIRITTE

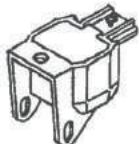

| art. | imballo | colore | euro |
|-------|---------|--------|------|
| P5002 | 15 pz. | bianco | 7,35 |

COPIA GIUDE PER ANGOLI

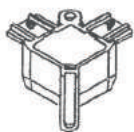

| art. | imballo | colore | euro |
|-------|---------|--------|------|
| P5003 | 15 pz. | bianco | 7,90 |

CARRELLO SORMONTO IN NYLON



| art. | imballo | colore | euro |
|-------|---------|--------|------|
| P5016 | 25 pz. | bianco | 0,80 |

CARRELLO SORMONTO IN FERRO



| art. | imballo | colore | euro |
|-------|---------|---------|------|
| P5015 | 25 pz. | zincato | 1,85 |

TAPPO



| art. | imballo | colore | euro |
|-------|---------|--------|------|
| P5006 | 50 pz. | bianco | 0,60 |

CORDA 100% NYLON Ø 3 mm



| art. | imballo | colore | euro |
|-------|---------|--------|--------|
| P4393 | 500 m | bianco | 106,81 |

FIOCCO BIANCO



| art. | imballo | colore | euro |
|-------|---------|--------|------|
| PP190 | 50 pz. | bianco | 2,45 |

CHIAVETTA CON RONDELLA



| art. | imballo | colore | euro |
|-------|---------|---------|------|
| P5007 | 50 pz. | zincato | 1,50 |

P1003

SISTEMI A STRAPPO E A CORDE PER AMBIENTI DOMESTICI, NAUTICO E CARAVAN



Dimensione profilo
L 10 mm
A 15 mm

Scala 1:1

Confezione standard con:

- art. P1002 - Binario bianco
- art. PH100 - Guida con rotelle
- art. PH110 - Carrello lama ferro
- art. PH125 - Carrello in plastica
- art. PH130 - Scivolo largo in materozza
- art. PH140 - Supporto a soffitto bianco
- art. PK190 - Fiocco bianco
- art. PK215 - Cordone da 2,5 mm



Indicato per tende medie. Il sistema è indicato per installazioni a soffitto, a parete o in libera sospensione. Nell'uso a strappo il sistema permette la realizzazione di sistemi curvi a 90° o centinati ad ampio raggio.

FISSAGGIO

Fissaggio a soffitto

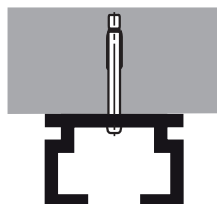

art. PH140 Fissaggio a soffitto con clip



SCORREVOLI

art. P4263 Scivolo in materozza



P1003

| LUNGHEZZA | 140 | 160 | 180 | 200 | 220 | 240 | 260 | 280 | 300 | 320 | 340 | 360 | 380 | 400 |
|------------------|-------|-------|-------|-------|-------|-------|-------|-------|-------|-------|-------|-------|-------|-------|
| PREZZO con CORDA | 43,47 | 45,84 | 48,20 | 50,62 | 52,53 | 54,74 | 56,91 | 59,23 | 61,65 | 62,98 | 65,30 | 69,01 | 72,20 | 74,57 |
| PREZZO a STRAPPO | 21,12 | 24,15 | 27,16 | 30,18 | 33,20 | 36,21 | 39,24 | 42,25 | 45,27 | 48,29 | 51,30 | 54,32 | 57,34 | 60,36 |

PROFILO IN ALLUMINIO 15 x 10 mm



| art. | imballo | colore | euro |
|-------|---------|---------|-------|
| P1003 | 60 m | bianco | 12,34 |
| P1003 | 60 m | Argento | 12,34 |

Lunghezza aste 6 m

SCIVOLO IN MATEROZZA



| art. | imballo | colore | euro |
|-------|----------|--------|-------|
| P4263 | 1000 pz. | | 8,09* |

*prezzo per 100 pz.

GUIDA IN PLASTICA CON ROTELLE

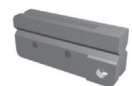

| art. | imballo | colore | euro |
|-------|---------|--------|------|
| PH105 | 50 pz. | | 2,49 |

SUPPORTO A SOFFIETTO

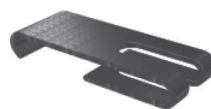

| art. | imballo | colore | euro |
|-------|---------|---------|------|
| PH140 | 100 pz. | argento | 1,03 |

CARRELLO LAMA FERRO



| art. | imballo | colore | euro |
|-------|---------|--------|------|
| PH110 | 50 pz. | | 6,33 |

FIOCCO BIANCO



| art. | imballo | colore | euro |
|-------|---------|--------|------|
| PP190 | 50 pz. | bianco | 2,45 |

CARRELLO IN PLASTICA PAR APERTURA CENTRALE



| art. | imballo | colore | euro |
|-------|---------|--------|------|
| PH125 | 100 pz. | | 1,18 |

CORDA 100% NYLON Ø 3 mm



| art. | imballo | colore | euro |
|-------|---------|--------|--------|
| P4393 | 500 m | bianco | 106,81 |

P1004

SISTEMA PER TENDE ARRICCIATE INDICATO PER PICCOLE FINESTRE



Dimensione profilo
L 10 mm
A 22,5 mm

Scala 1:1

Confezione standard con:

- art. P1003 - Binario bianco
- art. PK120 - Carrello in plastica autolubrificata
- art. PK145 - Scivolo in materozza
- art. PK160 - Supporto a soffitto a clip 2 cm
- art. PK187 - Coppia tappi con occhio per binario velcrato piccolo e P1002



Indicato per installazioni a soffitto o direttamente su serramenti in posizione orizzontale o verticale.
Curvabile. Profilo preforato.

FISSAGGIO

art. PK160 Fissaggio a soffitto a clip

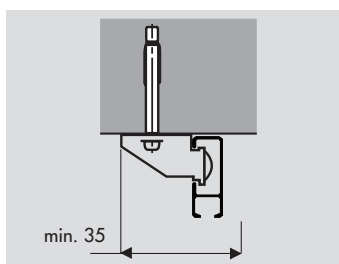

FISSAGGI OPZIONALI

art. PK175 Fissaggio a soffitto/parete a chiave 2 cm

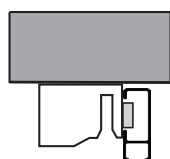

art. PK176 Fissaggio a soffitto/parete a chiave 6 cm

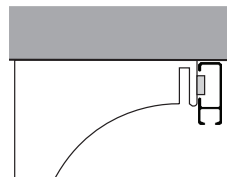

SCORREVOLI

art. PK145 Scivolo in materozza



CURVE

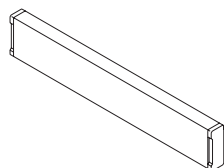

Diritto



Curva a 90°

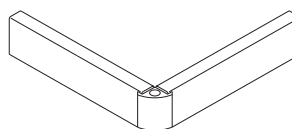

Angolo retto

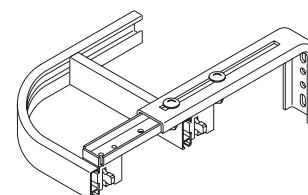

Curva a 90° + diritto

P1004

| | | | | | | | | | | | | | | |
|------------------|-------|-------|-------|-------|-------|-------|-------|-------|-------|-------|-------|-------|-------|-------|
| LUNGHEZZA | 120 | 140 | 160 | 180 | 200 | 220 | 240 | 260 | 280 | 300 | 320 | 340 | 360 | 380 |
| PREZZO a STRAPPO | 18,85 | 21,99 | 25,13 | 28,27 | 31,42 | 34,51 | 37,70 | 40,90 | 43,98 | 47,12 | 50,26 | 53,41 | 56,55 | 59,69 |

| | |
|------------------|-------|
| LUNGHEZZA | 400 |
| PREZZO a STRAPPO | 62,83 |

PROFILO IN ALLUMINIO 10 x 22,5 mm



| art. | imballo | colore | euro |
|-------|---------|--------|------|
| P1003 | 60 m | bianco | 7,54 |

Lunghezza aste 6 m

FERMO CON OCCHIOLO



| art. | imballo | colore | euro |
|-------|---------|--------|------|
| PK125 | 100 pz. | bianco | 0,46 |

BOTTONE DI SUPPORTO A SCOMPARSA



| art. | imballo | colore | euro |
|-------|---------|--------|------|
| PM141 | 100 pz. | bianco | 0,38 |

SCIVOLO IN MATEROZZA



| art. | imballo | colore | euro |
|-------|----------|--------|------------|
| PK145 | 1000 pz. | | 26,26 cad. |

*prezzo per 1000 pz.

SUPPORTO A SOFFITTO A CLIP - 2 cm



| art. | imballo | colore | euro |
|-------|---------|--------|------|
| PK160 | 100 pz. | | 0,55 |

SUPPORTO A SOFFITTO/PARETE A CHIAVETTA - 2 cm



| art. | imballo | colore | euro |
|-------|---------|--------|------|
| PK175 | 100 pz. | | 1,46 |

SUPPORTO A SOFFITTO/PARETE A CHIAVETTA - 6 cm



| art. | imballo | colore | euro |
|-------|---------|--------|------|
| PK176 | 100 pz. | | 1,60 |

TAPPO ANGOLARE PER BINARIO VELCRATO PICCOLO



| art. | imballo | colore | euro |
|-------|---------|--------|------|
| PK180 | 100 pz. | | 1,25 |

TAPPO BIANCO PER BINARIO VELCRATO PICCOLO



| art. | imballo | colore | euro |
|-------|---------|--------|------|
| PK186 | 100 pz. | | 0,52 |

P1005

SISTEMA PER TENDE A PACCHETTO CON AZIONAMENTO A CORDA



Dimensione profilo
L 10 mm
A 22,5 mm

Scala 1:1



Confezione standard con:

- art. P1004 - Binario veltrato bianco
- art. PM040 - Piattina peso 4x40 bianca
- art. PM125 - Comando fermacorda
- art. PM135 - Passante per cordino con puleggia
- art. PK186 - Tappo bianco per profilo veltrato
- art. PK225 - Corda da 1,2 mm
- art. PM230 - Giunzione per corda in plastica
- art. PM235 - Nappina bianca in plastica
- art. PK160 - Supporto a soffitto

Sistema per tende a pacchetto con azionamento a corda.
Indicato per ambienti domestici o professionali

FISSAGGIO

art. PK160 Fissaggio a soffitto a clip

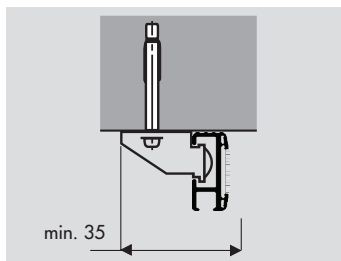

FISSAGGI OPZIONALI

art. PK175 Fissaggio a soffitto/parete a chiave 2 cm

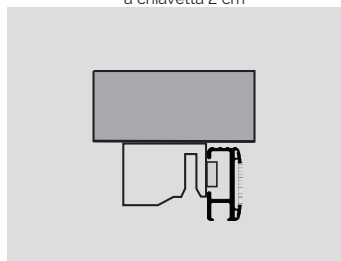

art. PK176 Fissaggio a soffitto/parete a chiave 6 cm

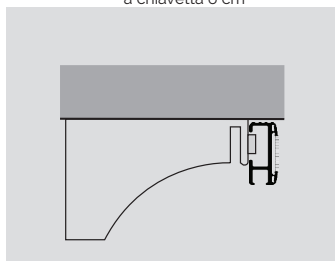

P1005

| LUNGHEZZA | 100 | 120 | 140 | 160 | 180 | 200 | 220 | 240 | 260 | 280 | 300 |
|-------------|-------|-------|-------|-------|-------|-------|-------|-------|-------|-------|-------|
| PREZZO | 39,29 | 47,15 | 51,60 | 58,97 | 62,11 | 68,39 | 72,20 | 76,68 | 80,86 | 83,43 | 89,35 |
| N. SUPPORTI | 3 | 3 | 3 | 4 | 4 | 5 | 5 | 5 | 6 | 6 | 7 |

PROFILO IN ALLUMINIO 10 x 22,5 mm



| art. | imballo | colore | euro |
|-------|---------|--------|------|
| P1006 | 60 m | bianco | 8,81 |

Lunghezza aste 6 m

PIATTINA PESO TENDA



| art. | imballo | mm | euro |
|-------|---------|--------|------|
| P4124 | 60 m. | 4 x 30 | 7,54 |
| P4125 | 60 m. | 4 x 40 | 8,81 |

*lunghezza aste 6m

FERMACORDA CON ROTELLE IN OTTONE



| art. | imballo | colore | euro |
|-------|---------|--------|------|
| PM125 | 100 pz. | bianco | 5,56 |

PASSANTE PER CORDINO



| art. | imballo | colore | euro |
|-------|---------|--------|------|
| PM135 | 100 pz. | bianco | 2,16 |

CORDINA ø 1,2 mm



| art. | imballo | colore | euro |
|-------|---------|--------|-------|
| P4121 | 500 m | | 61,60 |

GIUNZIONE PER CORDE IN PLASTICA



| art. | imballo | colore | euro |
|-------|---------|--------|------|
| PM230 | 100 pz. | bianco | 0,41 |

GIUNZIONE PER CORDE IN ALLUMINIO



| art. | imballo | colore | euro |
|-------|---------|--------|------|
| PM232 | 100 pz. | | 1,47 |

NAPPINA IN PLASTICA



| art. | imballo | colore | euro |
|-------|---------|--------|------|
| PM235 | 100 pz. | bianco | 0,93 |

SUPPORTO A SOFFITTO A CLIP - 2 cm



| art. | imballo | colore | euro |
|-------|---------|--------|------|
| PK160 | 100 pz. | | 0,55 |

TAPPO BIANCO PER BINARIO VELCRATO PICCOLO



| art. | imballo | colore | euro |
|-------|---------|--------|------|
| PK186 | 100 pz. | | 0,52 |

SUPPORTO A SOFFITTO/PARETE A CHIAVETTA - 2 cm



| art. | imballo | colore | euro |
|-------|---------|--------|------|
| PK175 | 100 pz. | | 1,46 |

TONDINO



| art. | imballo | o | euro |
|------|---------|------------|------|
| TT6 | 120 m | 6 mm AL | 4,02 |
| TT8 | 120 m | 8 mm AL | 3,81 |
| 4078 | 60 m | 4 mm Fibra | 1,85 |

SUPPORTO A SOFFITTO/PARETE A CHIAVETTA - 6 cm



| art. | imballo | colore | euro |
|-------|---------|--------|------|
| PK176 | 100 pz. | | 1,60 |

TONDINO FIBRA DI VETRO



| art. | imballo | o | euro |
|-------|---------|------------|------|
| P4078 | 120 m. | 4 mm FIBRA | 1,91 |

*lunghezza aste 6 m

P1006

SISTEMA PER TENDE A PACCHETTO CON AZIONAMENTO A CORDA



Dimensione profilo
L 10 mm
A 22,5 mm

Scala 1:1

Confezione standard con:

- art. P1004 - Binario veltrato bianco
- art. PK186 - Tappo bianco per binario veltrato
- art. PM035 - Piattina peso 4x30 bianca
- art. PM120 - Comando fermacorda
- art. PM130 - Passante per cordino
- art. PM140 - Bottone di supporto a scomparsa
- art. PK225 - Corda da 1,2 mm
- art. PM230 - Giunzione per corda in plastica
- art. PM235 - Nappina in plastica



Sistema per tende a pacchetto con azionamento a corda.
Indicato per ambienti domestici o professionali

FISSAGGIO

FISSAGGI OPZIONALI

art. PM140 Fissaggio a parete

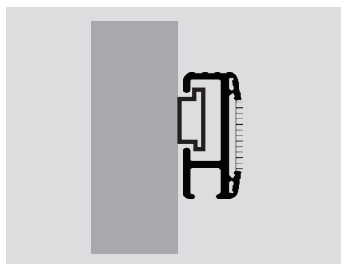

art. PK160 Fissaggio a soffitto a clip

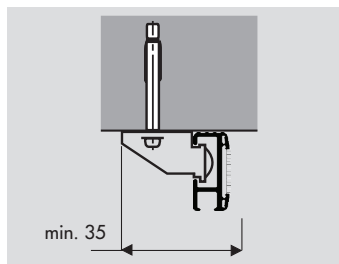

art. PK175 Fissaggio a soffitto/parete a chiave 2 cm

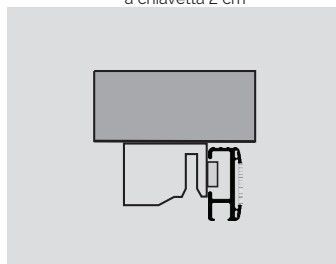

art. PK176 Fissaggio a soffitto/parete a chiave 6 cm

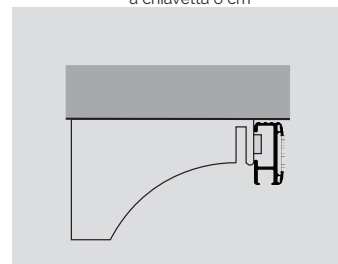

INSTALLAZIONI

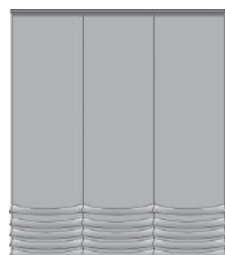

Pacchetto semplice



Pacchetto arricciato



Pacchetto steccato

P1006

| | | | | | | | | | |
|-----------|-------|-------|-------|-------|-------|-------|-------|-------|-------|
| LUNGHEZZA | 40 | 50 | 60 | 70 | 80 | 90 | 100 | 120 | 150 |
| PREZZO | 22,62 | 25,13 | 26,42 | 28,90 | 30,16 | 32,67 | 32,09 | 40,21 | 43,98 |
| N. CADUTE | 2 | 2 | 2 | 2 | 3 | 3 | 3 | 4 | 4 |

PROFILO IN ALLUMINIO 10 x 22,5 mm



| art. | imballo | colore | euro |
|-------|---------|--------|------|
| P1006 | 60 m | bianco | 8,81 |

Lunghezza aste 6 m

PIATTINA PESO TENDA



| art. | imballo | mm | euro |
|-------|---------|--------|------|
| P4124 | 60 m. | 4 x 30 | 7,54 |
| P4125 | 60 m. | 4 x 40 | 8,81 |

*lunghezza aste 6m

BOTTONE DI SUPPORTO A SCOMPARSA



| art. | imballo | colore | euro |
|-------|---------|--------|------|
| PM141 | 100 pz. | bianco | 0,38 |

CORDINA ø 1.2 mm



| art. | imballo | colore | euro |
|-------|---------|--------|-------|
| P4121 | 500 m | | 61,60 |

GIUNZIONE PER CORDE IN PLASTICA



| art. | imballo | colore | euro |
|-------|---------|--------|------|
| PM230 | 100 pz. | bianco | 0,41 |

GIUNZIONE PER CORDE IN ALLUMINIO



| art. | imballo | colore | euro |
|-------|---------|--------|------|
| PM232 | 100 pz. | | 1,47 |

NAPPINA IN PLASTICA



| art. | imballo | colore | euro |
|-------|---------|--------|------|
| PM235 | 100 pz. | bianco | 0,93 |

FRIZIONE LAVAGGIO RAPIDO



| art. | imballo | colore | euro |
|-------|---------|--------|----------|
| P1006 | 50 pz. | | 4,02 cad |

PASSACORDA APERTO



| art. | imballo | colore | euro |
|-------|---------|--------|----------|
| P1007 | 100 pz. | | 0,57 cad |

SUPPORTO A SOFFITTO A CLIP - 2 cm



| art. | imballo | colore | euro |
|-------|---------|--------|------|
| PK160 | 100 pz. | | 0,55 |

SUPPORTO A SOFFITTO/PARETE A CHIAVETTA - 2 cm



| art. | imballo | colore | euro |
|-------|---------|--------|------|
| PK175 | 100 pz. | | 1,46 |

SUPPORTO A SOFFITTO/PARETE A CHIAVETTA - 6 cm



| art. | imballo | colore | euro |
|-------|---------|--------|------|
| PK176 | 100 pz. | | 1,60 |

TAPPO BIANCO PER BINARIO VELCRATO PICCOLO



| art. | imballo | colore | euro |
|-------|---------|--------|------|
| PK186 | 100 pz. | | 0,52 |

TONDINO



| art. | imballo | o | euro |
|------|---------|-----------------|------|
| TT6 | 120 m | 6 mm AL | 4,02 |
| TT8 | 120 m | 8 mm AL | 3,81 |
| 4078 | 60 m | 4 mm Fibra 1,85 | |

GANCI PER NON BUCARE CON BOTTONE - SPESSORE 6 mm

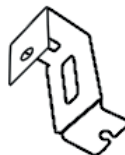

| art. | colore | mat. | euro |
|------|----------------|-----------|------|
| PK06 | bianco/marrone | alluminio | 3,70 |

*imballo 50pz

GANCI PER NON BUCARE CON BOTTONE - SPESSORE 16 mm

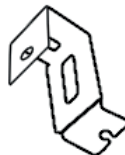

| art. | colore | mat. | euro |
|------|----------------|------|------|
| PK16 | bianco/marrone | pvc | 3,70 |

*imballo 50pz

GANCI PER NON BUCARE CON BOTTONE - SPESSORE 22 mm

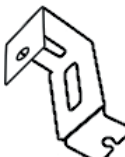

| art. | colore | mat. | euro |
|------|----------------|------|------|
| PK22 | bianco/marrone | pvc | 3,70 |

*imballo 50pz

P1106

SISTEMA VELCRATO PER TENDE TESE



Dimensione profilo
L 10 mm
A 22,5 mm

Scala 1:1

Confezione standard con:

- art. P1004 - Binario velcrato bianco
- art. PK186 - Tappo bianco per binario velcrato
- art. PM040 - Piattina peso 4x40 bianca
- art. PM140 - Bottone di supporto a scomparsa



Sistema per tenda a vetro fissa

FISSAGGIO

art. PM140 Fissaggio a parete

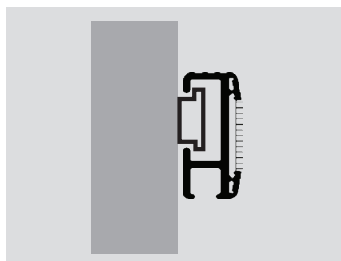

FISSAGGI OPZIONALI

art. PK160 Fissaggio a soffitto a clip

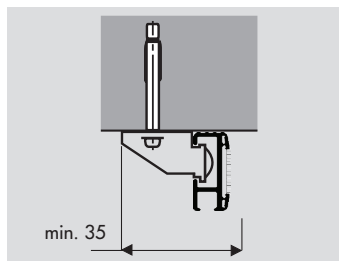

art. PK175 Fissaggio a soffitto/parete a chiave 2 cm

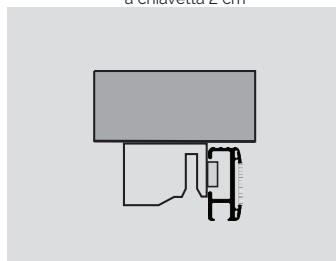

art. PK176 Fissaggio a soffitto/parete a chiave 6 cm

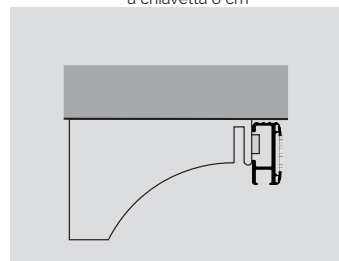

P1106

LUNGHEZZA

40 50 60 70 80 90 100 110 120 130 140 150

PREZZO

8.03 10.04 12.05 14.06 16.07 18.08 20.09 22.09 24.10 26.11 28.12 30.13

PROFILO IN ALLUMINIO 10 x 22,5 mm



| art. | imballo | colore | euro |
|-------|---------|--------|------|
| P1006 | 60 m | bianco | 8,81 |

Lunghezza aste 6 m

PIATTINA PESO TENDA



| art. | imballo | mm | euro |
|-------|---------|--------|------|
| P4124 | 60 m. | 4 x 30 | 7,54 |
| P4125 | 60 m. | 4 x 40 | 8,81 |

*lunghezza aste 6m

TAPPO BIANCO PER BINARIO VELCRATO PICCOLO



| art. | imballo | colore | euro |
|-------|---------|--------|------|
| PK186 | 100 pz. | | 0,52 |

TAPPO ANGOLARE PER BINARIO VELCRATO PICCOLO



| art. | imballo | colore | euro |
|-------|---------|--------|------|
| PK180 | 100 pz. | | 1,25 |

BOTTONE DI SUPPORTO A SCOMPARSA



| art. | imballo | colore | euro |
|-------|---------|--------|------|
| PM141 | 100 pz. | bianco | 0,38 |

SUPPORTO A SOFFITTO A CLIP - 2 cm



| art. | imballo | colore | euro |
|-------|---------|--------|------|
| PK160 | 100 pz. | | 0,55 |

SUPPORTO A SOFFITTO/PARETE A CHIAVETTA - 2 cm



| art. | imballo | colore | euro |
|-------|---------|--------|------|
| PK175 | 100 pz. | | 1,46 |

SUPPORTO A SOFFITTO/PARETE A CHIAVETTA - 6 cm



| art. | imballo | colore | euro |
|-------|---------|--------|------|
| PK176 | 100 pz. | | 1,60 |

P1126-36-46-56

SISTEMA PER TENDE A PANNELLI A STRAPPO E CORDA

Dimensione profilo
L 36,7 mm
A 16,5 mm



Dimensione profilo
L 49 mm
A 16,5 mm



Dimensione profilo
L 67 mm
A 16,5 mm



Dimensione profilo
L 85 mm
A 16,5 mm



Confezione standard con:

- art. P1046 - Binario a 4 vie bianco
- art. PP104 - Coppia tappi a 4 vie
- art. PP304 - Coppia testate guidacorda a 4 vie
- art. PP310 - Angolare a "T" per portatelo
- art. PP315 - Angolare a "L" per portatelo
- art. PP120 - Ammortizzatore
- art. PP325 - Vite di arresto
- art. PP135 - Chiavetta per binari 3-4-5 vie
- art. PP140 - Barra velcrata in PVC
- art. PP145 - Rullo in Delrin tornito
- art. PM040 - Piattina peso bianca 4x40 mm
- art. PP334 - Asta guidatenda manico legno 1 mt
- art. PK214 - Cordone da 4 mm
- art. PP320 - Giunzione per corda
- art. PK190 - Fiocco bianco



Azionamento con corde.
P1126: 2 canali - P1136: 3 canali - P1146: 4 canali - P1156: 5 canali.
L'applicazione in parallelo di sistemi diversi permette la realizzazione delle più svariate soluzioni.

FISSAGGI

art. P4483 Fissaggio a soffitto P1126
art. P4161 Fissaggio a soffitto P1126
P1136 - P1146 - P1156

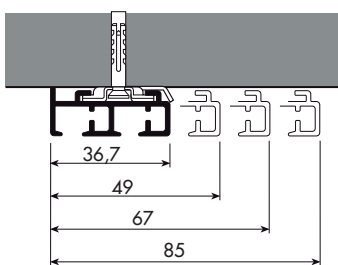

art. P4142 Fissaggio a parete

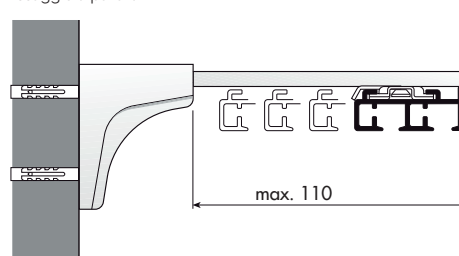

P1126 - 2 vie

| LUNGHEZZA | 120 | 150 | 180 | 200 | 250 | 300 | 350 | 400 |
|-----------|-------|-------|-------|-------|--------|--------|--------|--------|
| STRAPPO | 45,24 | 56,55 | 67,86 | 75,40 | 94,25 | 113,09 | 131,94 | 150,79 |
| VINCOLATO | 51,29 | 64,07 | 76,91 | 85,45 | 106,81 | 128,17 | 149,54 | 170,90 |
| CORDA | 57,31 | 71,63 | 85,95 | 95,50 | 119,38 | 142,22 | 167,13 | 191,00 |

P1136 - 3 vie

| LUNGHEZZA | 180 | 200 | 250 | 300 | 350 | 400 | 450 | 500 | 550 | 600 |
|-----------|--------|--------|--------|--------|--------|--------|--------|--------|--------|--------|
| STRAPPO | 87,96 | 95,50 | 123,15 | 144,51 | 163,36 | 175,92 | 194,77 | 213,62 | 232,47 | 251,32 |
| VINCOLATO | 103,05 | 110,57 | 138,23 | 162,12 | 180,97 | 196,03 | 214,88 | 236,24 | 252,58 | 276,45 |
| CORDA | 106,30 | 113,09 | 141,37 | 169,64 | 197,91 | 226,19 | 254,46 | 282,74 | 311,01 | 339,28 |

P1146 - 4 vie

| | | | | | | | | | |
|-----------|--------|--------|--------|--------|--------|--------|--------|--------|--------|
| LUNGHEZZA | 200 | 250 | 300 | 350 | 400 | 450 | 500 | 550 | 600 |
| STRAPPO | 110,62 | 128,75 | 154,50 | 180,25 | 206,00 | 231,75 | 257,50 | 283,25 | 309,00 |
| VINCOLATO | 113,30 | 142,27 | 170,72 | 199,18 | 227,63 | 256,09 | 284,54 | 313,00 | 341,45 |
| CORSA | 118,45 | 148,06 | 177,68 | 207,29 | 236,90 | 266,51 | 296,13 | 325,74 | 355,35 |

P1156 - 5 vie

| | | | | | | | | | |
|-----------|--------|--------|--------|--------|--------|--------|--------|--------|--------|
| LUNGHEZZA | 200 | 250 | 300 | 350 | 400 | 450 | 500 | 550 | 600 |
| STRAPPO | 111,24 | 139,05 | 166,86 | 194,67 | 222,48 | 250,29 | 278,10 | 305,91 | 333,72 |
| VINCOLATO | 125,66 | 157,08 | 188,49 | 219,91 | 251,32 | 282,74 | 314,15 | 345,57 | 376,98 |
| CORDA | 136,48 | 170,60 | 204,71 | 238,84 | 272,95 | 307,07 | 341,19 | 375,31 | 409,43 |

PROFILO ALLUMINIO 36,7 x 16,5 mm



| art. | imballo | colore | euro |
|-------|---------|--------|-------|
| P1126 | 60m | bianco | 11,50 |

*lunghezza aste 6 m

PROFILO ALLUMINIO 49 x 1,65 mm

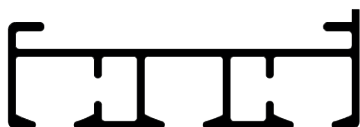

| art. | imballo | colore | euro |
|-------|---------|--------|-------|
| P1136 | 60m | bianco | 13,25 |

*lunghezza aste 6 m

PROFILO ALLUMINIO 67 x 1,65 mm



| art. | imballo | colore | euro |
|-------|---------|--------|-------|
| P1146 | 60m | bianco | 18,40 |

*lunghezza aste 6 m

PROFILO ALLUMINIO 85 x 1,65 mm

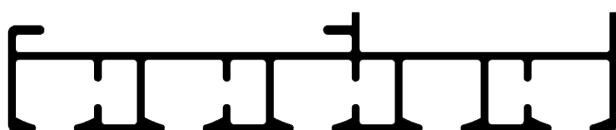

| art. | imballo | colore | euro |
|-------|---------|--------|-------|
| P1156 | 60m | bianco | 22,50 |

*lunghezza aste 6 m

COPPIA TAPPI A 2 VIE



| art. | imballo | colore | euro |
|-------|---------|--------|------|
| PP102 | 20 pz. | | 2,00 |

COPPIA TAPPI A 5 VIE



| art. | imballo | colore | euro |
|-------|---------|--------|------|
| PP105 | 20 pz. | | 3,25 |

COPPIA TAPPI A 3 VIE



| art. | imballo | colore | euro |
|-------|---------|--------|------|
| PP103 | 20 pz. | | 2,60 |

COPPIA TAPPI A 2 VIE COMANDO CORDA



| art. | imballo | colore | euro |
|-------|---------|--------|------|
| PK205 | 100 pz. | | 2,00 |

COPPIA TAPPI A 4 VIE



| art. | imballo | colore | euro |
|-------|---------|--------|------|
| PP104 | 20 pz. | | 2,90 |

COPPIA TAPPI A 3 VIE COMANDO CORDA



| art. | imballo | colore | euro |
|-------|---------|--------|-------|
| PK305 | 100 pz. | | 11,75 |

COPPIA TAPPI A 4 VIE COMANDO CORDA

| art. | imballo | colore | euro |
|-------|---------|--------|-------|
| PK405 | 100 pz. | | 13,20 |



COPPIA TAPPI A 5 VIE COMANDO CORDA

| art. | imballo | colore | euro |
|-------|---------|--------|-------|
| PK505 | 100 pz. | | 16,10 |



BARRA VELCRATA IN PVC 4 m

| art. | imballo | colore | euro |
|-------|---------|--------|------|
| PP140 | 80 m | | 9,15 |



RULLO IN NYLON STAMPATO

| art. | imballo | colore | euro |
|-------|---------|--------|------|
| PP140 | 250 pz. | | 0,25 |



GIUNZIONE PER BINARIO A 2 VIE

| art. | imballo | colore | euro |
|-------|---------|--------|------|
| PP200 | 10 pz. | | 5,50 |



GIUNZIONE PER BINARIO A 3 - 4 - 5 VIE

| art. | imballo | colore | euro |
|-------|---------|--------|------|
| PP210 | 10 pz. | | 5,50 |



ANGOLARE A "T" PER PORTATELO

| art. | imballo | colore | euro |
|-------|---------|--------|------|
| PP310 | 100 pz. | | 0,90 |



ANGOLARE A "L" PER PORTATELO

| art. | imballo | colore | euro |
|-------|---------|--------|------|
| PP315 | 100 pz. | | 0,90 |



VITE DI ARRESTO

| art. | imballo | colore | euro |
|-------|---------|--------|------|
| PP325 | 100 pz. | | 0,50 |



ASTA GUIDATENDA IN FERRO RIVESTITO

| art. | imballo | cm | euro |
|-------|---------|-----|------|
| PP330 | 10 pz. | 100 | 3,80 |
| PP330 | 10 pz. | 125 | 4,15 |
| PP330 | 10 pz. | 150 | 4,40 |



ASTA GUIDATENDA TRASPARENTE

| art. | imballo | cm | euro |
|---------|---------|-----|------|
| PP332/1 | 10 pz. | 100 | 4,40 |
| PP332/2 | 10 pz. | 125 | 5,15 |
| PP332/3 | 10 pz. | 150 | 5,90 |



VELCRO ASOLA DA CUCIRE

| art. | imballo | colore | euro |
|-------|---------|--------|------|
| PP570 | 25 m | | 0,65 |



PIATTINA PESO TENDA

| art. | imballo | mm | euro |
|-------|---------|--------|------|
| P4124 | 60 m. | 4 x 30 | 7,54 |
| P4125 | 60 m. | 4 x 40 | 8,81 |



*lunghezza aste 6m

MENSOLA A PARETE REGOLABILE

| art. | sporgenza | imballo | euro |
|-------|-----------|---------|------|
| P4142 | 10-15 cm | 10 pz. | 5,10 |
| P4142 | 16-20 cm | 10 pz. | 5,67 |
| P4142 | 21-25 cm | 10 pz. | 6,03 |

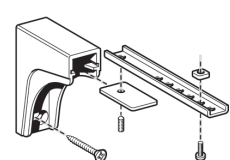

CHIAVETTA PER BINARI A 2 VIE

| art. | imballo | colore | euro |
|-------|---------|--------|------|
| PP130 | 100 pz. | | 1,50 |



CHIAVETTA PER BINARI A 3 - 4 - 5 VIE

| art. | imballo | colore | euro |
|-------|---------|--------|------|
| PP135 | 100 pz. | | 2,05 |



FIOTTO BIANCO

| art. | imballo | colore | euro |
|-------|---------|--------|------|
| PP190 | 50 pz. | bianco | 2,45 |



CORDA 100% NYLON Ø 3 mm

| art. | imballo | colore | euro |
|-------|---------|--------|--------|
| P4393 | 500 m | bianco | 106,81 |



Handwriting practice lines consisting of 20 horizontal grey lines.

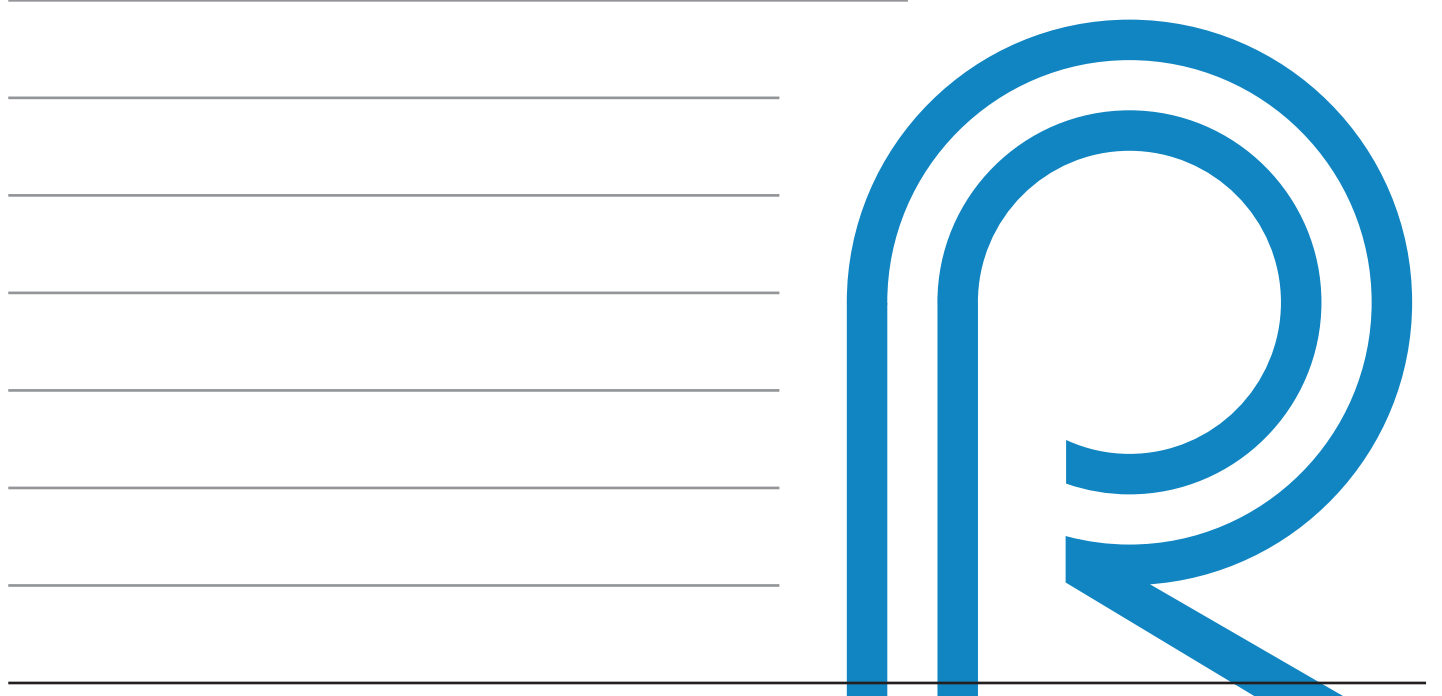



ROBERTO PANZERI

ARTICOLI PER TAPPEZZIERI - SISTEMI PER TENDAGGI - PASSAMANERIA

22053 LECCO - Via Monterotondo, 10 - Tel.(0341) 498338 - Fax(0341) 255633
Deposito: 56021 CASCINA - Via Carducci, 29 - Tel.(050) 700964 - Fax(050) 703774
e-mail: roberto.panzeri@virgilio.it